

Moving Charges and Magnetism

Question1

Two long straight wires P and Q carrying equal current 10A each were kept parallel to each other at 5 cm distance. Magnitude of magnetic force experienced by 10 cm length of wire P is F_1 . If distance between wires is halved and currents on them are doubled, force F_2 on 10 cm length of wire P will be :
[24-Jan-2023 Shift 1]

Options:

- A. $8F_1$
- B. $10F_1$
- C. $F_1 / 8$
- D. $F_1 / 10$

Answer: A

Solution:

Solution:

Force per unit length between two parallel straight

$$\begin{aligned} \text{wires} &= \frac{\mu_0 i_1 i_2}{2\pi d} \\ \frac{F_1}{F_2} &= \frac{\mu_0 (10)^2}{2\pi (5 \text{ cm})} = \frac{1}{8} \\ &= \frac{\mu_0 (20)^2}{2\pi \left(\frac{5 \text{ cm}}{2}\right)} \\ \Rightarrow F_2 &= 8F_1 \end{aligned}$$

Question2

A circular loop of radius r is carrying current I A. The ratio of magnetic field at the centre of circular loop and at a distance r from the center of the loop on its axis is :
[24-Jan-2023 Shift 1]

Options:

- A. $1 : 3\sqrt{2}$
- B. $3\sqrt{2} : 2$

C. $2\sqrt{2} : 1$

D. $1 : \sqrt{2}$

Answer: C

Solution:

Solution:

Magnetic field due to current carrying circular loop on its axis is given as

$$\frac{\mu_0 i r^2}{2(r^2 + x^2)^{3/2}}$$

At centre, $x = 0$, $B_1 = \frac{\mu_0 i}{2r}$

At $x = r$, $B_2 = \frac{\mu_0 i}{2 \times 2\sqrt{2}r}$

$$\frac{B_1}{B_2} = 2\sqrt{2}$$

Question3

A long solenoid is formed by winding 70 turns cm^{-1} . If 2.0A current flows, then the magnetic field produced inside the solenoid is__

($\mu_0 = 4\pi \times 10^{-7} \text{TmA}^{-1}$)

[24-Jan-2023 Shift 2]

Options:

A. $1232 \times 10^{-4} \text{T}$

B. $176 \times 10^{-4} \text{T}$

C. $352 \times 10^{-4} \text{T}$

D. $88 \times 10^{-4} \text{T}$

Answer: B

Solution:

Solution:

$$\begin{aligned} B &= \mu_0 nI \\ &= 4\pi \times 10^{-7} \times 70 \times 10^2 \times 2 \\ &= 56\pi \times 10^{-4} \text{T} \\ &= 176 \times 10^{-4} \text{T} \end{aligned}$$

Question4

A single turn current loop in the shape of a right angle triangle with sides 5 cm, 12 cm, 13 cm is carrying a current of 2A. The loop is in a uniform magnetic field of magnitude 0.75T whose direction is parallel



to the current in the 13 cm side of the loop. The magnitude of the magnetic force on the 5 cm side will be $\frac{x}{130}$ N. The value of x is ____
 [24-Jan-2023 Shift 2]

ANSWER: 9

Solution:

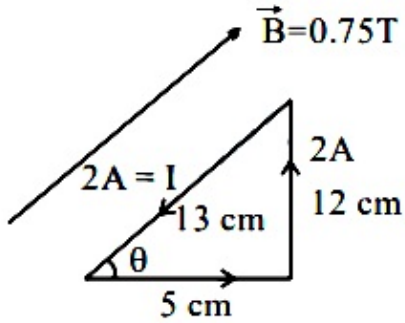

Force on 5 cm side is

$$|\vec{F}| = ILB \sin \theta$$

$$= (2)(5 \times 10^{-2}) \times \frac{3}{4} \times \frac{12}{13} = \frac{9}{130} \text{ N}$$

So, $x = 9$

Question 5

Math List I with List II

List – I (Current configuration)		List – II (Magnetic field at point O)	
A		I.	$B_0 = \frac{\mu_0 I}{4\pi r} [\pi + 2]$
B		II.	$B_0 = \frac{\mu_0 I}{4 r}$
C		III.	$B_0 = \frac{\mu_0 I}{2\pi r} [\pi - 1]$
D		IV	$B_0 = \frac{\mu_0 I}{4\pi r} [\pi + 1]$

**Choose the correct answer from the option given below:
[25-Jan-2023 Shift 1]**

Options:

- A. A-III, B-IV, C-I, D-II
- B. A-I, B-III, C-IV, D-II
- C. A-III, B-I, C-IV, D-II
- D. A-II, B-I, C-IV, D-III

Answer: C

Solution:

Solution:
(A)

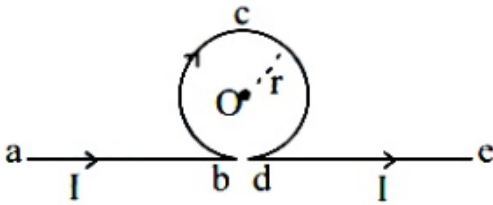

$$B_{ab} = \frac{\mu_0 I}{4\pi r} \text{ (out of the plane)}$$

$$B_{bcd} = \frac{\mu_0 I}{4\pi r} (2\pi) \text{ (in the plane)}$$

$$B_{de} = \frac{\mu_0 I}{4\pi r} \text{ (out of the plane)}$$

Hence magnetic field at O is

$$B_0 = -\frac{\mu_0 I}{4\pi r} + \frac{\mu_0 I}{4\pi r} (2\pi) - \frac{\mu_0 I}{4\pi r}$$

$$B_0 = \frac{\mu_0 I}{2\pi r} (\pi - 1) \dots \dots \dots \text{ (III)}$$

(B)

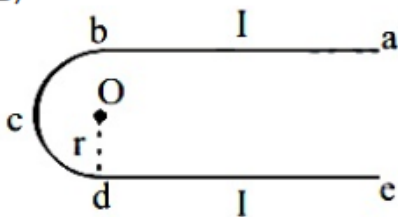

$$B_{ab} = \frac{\mu_0 I}{4\pi r} \text{ (out of the plane)}$$

$$B_{bcd} = \frac{\mu_0 I}{4\pi r}(\pi) \text{ (out of the plane)}$$

$$B_{de} = \frac{\mu_0 I}{4\pi r} \text{ (out of the plane)}$$

Hence magnetic field at O is

$$B_0 = \frac{\mu_0 I}{4\pi r} + \frac{\mu_0 I}{4\pi r}(\pi) + \frac{\mu_0 I}{4\pi r}$$

$$B_0 = \frac{\mu_0 I}{4\pi r}(\pi + 2) \dots (I)$$

(C)

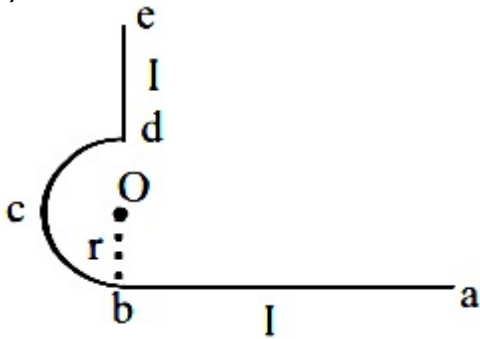

$$B_{ab} = \frac{\mu_0 I}{4\pi r} \text{ (in the plane)}$$

$$B_{bcd} = \frac{\mu_0 I}{4\pi r}(\pi) \text{ (in the plane)}$$

$$B_{de} = 0 \text{ (at the axis)}$$

Hence magnetic field at O is

$$B_0 = \frac{\mu_0 I}{4\pi r}(1 + \pi) \dots$$

(D)

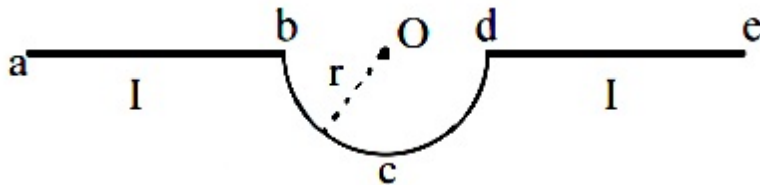

$$B_{ab} = 0 \text{ (at the axis)}$$

$$B_{bcd} = \frac{\mu_0 I}{4\pi r}(\pi) \text{ (out of the plane)}$$

$$B_{de} = 0 \text{ (at the axis)}$$

Hence magnetic field at O is

$$B_0 = \frac{\mu_0 I}{4r} \dots$$

Question6

A solenoid of 1200 turns is wound uniformly in a single layer on a glass tube 2m long and 0.2m in diameter. The magnetic intensity at the center of the solenoid when a current of 2 A flows through it is:
[25-Jan-2023 Shift 1]

Options:

- A. $2.4 \times 10^3 \text{Am}^{-1}$
- B. $1.2 \times 10^3 \text{Am}^{-1}$
- C. 1Am^{-1}
- D. $2.4 \times 10^{-3} \text{Am}^{-1}$

Answer: B

Solution:

Solution:

Magnetic field at centre inside the solenoid is given by

$$B = \mu_0 nI$$

So magnetic intensity at centre

$$H = \frac{B}{\mu_0} = nI = \left(\frac{1200}{2} \right) (2)$$

$$H = 1.2 \times 10^3 \text{Am}^{-1}$$

Question7

For a moving coil galvanometer, the deflection in the coil is 0.05 rad when a current of 10 mA is passed through it. If the torsional constant of suspension wire is $4.0 \times 10^{-5} \text{Nm rad}^{-1}$, the magnetic field is 0.01T and the number of turns in the coil is 200 , the area of each turn (in cm^2) is :

[25-Jan-2023 Shift 2]

Options:

- A. 2.0
- B. 1.0
- C. 1.5
- D. 0.5

Answer: B

Solution:



$$\tau = K\theta$$

$$NiAB = K\theta$$

$$A = \frac{K\theta}{NiB} = \frac{4 \times 10^{-5} \times 0.05}{200 \times 10 \times 10^{-3} \times 0.01}$$

On solving $A = 10^{-4} \text{m}^2 = 1 \text{cm}^2$

Question8

Two long parallel wires carrying currents 8A and 15A in opposite directions are placed at a distance of 7 cm from each other. A point P is at equidistant from both the wires such that the lines joining the point P to the wires are perpendicular to each other. The magnitude of magnetic field at P is _____ $\times 10^{-6} \text{T}$. (Given : $\sqrt{2} = 1.4$)
[25-Jan-2023 Shift 2]

Solution:

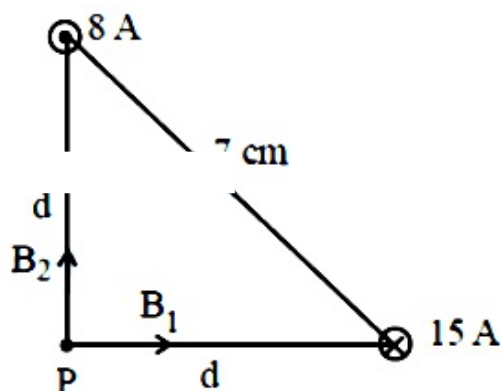

Magnetic fields due to both wires will be perpendicular to each other.

$$B_1 = \frac{\mu_0 i_1}{2\pi d} \quad B_2 = \frac{\mu_0 i_2}{2\pi d}$$

$$B_{\text{net}} = \sqrt{B_1^2 + B_2^2} \Rightarrow \frac{\mu_0}{2\pi d} \sqrt{i_1^2 + i_2^2}$$

$$\Rightarrow \frac{4\pi \times 10^{-7}}{2\pi \times (7/\sqrt{2}) \times 10^{-2}} \times \sqrt{8^2 + 15^2} \left(d = \frac{7}{\sqrt{2}} \text{cm} \right)$$

$$\Rightarrow 68 \times 10^{-6} \text{T}$$

Question9

A single current carrying loop of wire carrying current I flowing in anticlockwise direction seen from +ve z direction and lying in xy plane is shown in figure. The plot of \hat{j} component of magnetic field (B_y) at a distance 'a' (less than radius of the coil) and on yz plane vs z coordinate look like

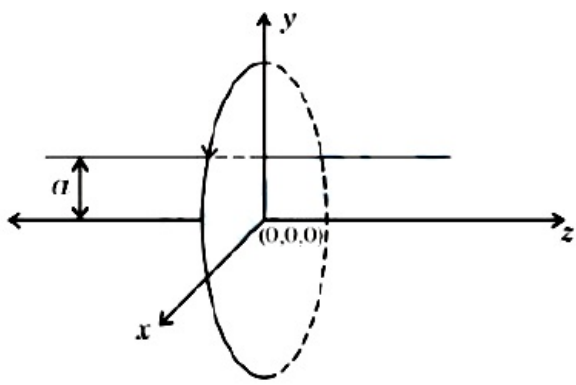

[29-Jan-2023 Shift 1]

Options:

A.

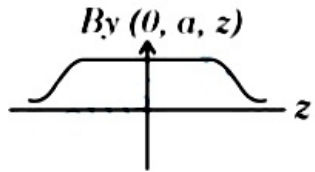

B.

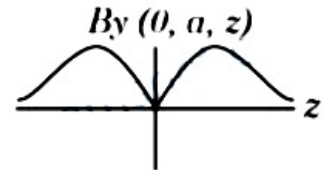

C.

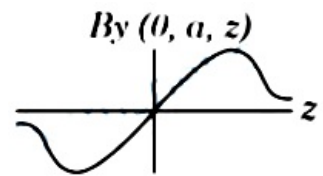

D.

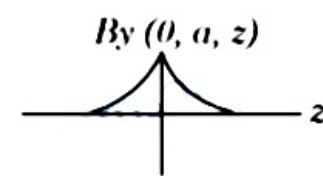

Answer: C

Solution:

Solution:

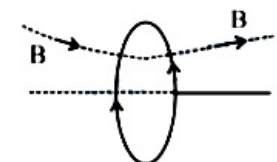

$B_y = 0$ in plane of coil
 B_y is opposite of each other in $-z$ and $+z$ positions.

Question10

The magnitude of magnetic induction at mid-point O due to current arrangement as shown in Fig will be :

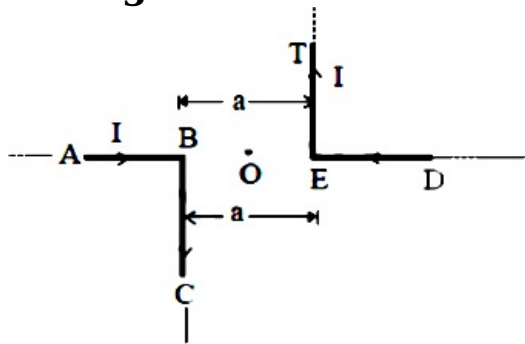

[29-Jan-2023 Shift 1]

Options:

A. $\frac{\mu_0 I}{2\pi a}$

B. 0

C. $\frac{\mu_0 I}{4\pi a}$

D. $\frac{\mu_0 I}{\pi a}$

Answer: D

Solution:

Solution:

Magnetic field due to current in BC and ET are outward at point 'O'

$$B_0 = \frac{\mu_0 i}{4\pi r} + \frac{\mu_0 i}{4\pi r} = \frac{\mu_0 i}{2\pi r} = \frac{\mu_0 i}{\pi a}$$

Question11

A square loop of area 25cm^2 has a resistance of 10Ω . The loop is placed in uniform magnetic field of magnitude 40.0 T . The plane of loop is perpendicular to the magnetic field. The work done in pulling the loop out of the magnetic field slowly and uniformly in 1.0 sec , will be

[29-Jan-2023 Shift 2]

Options:

A. $2.5 \times 10^{-3}\text{J}$

B. $1.0 \times 10^{-3}\text{J}$

C. $1.0 \times 10^{-4}\text{J}$

D. $5 \times 10^{-3}\text{J}$

Answer: B

Solution:

Solution:

Sol. $l = 50\text{ cm}$

$t = 1\text{ sec}$

$\therefore v = \frac{0.05}{1} = 0.05\text{m / s .}$

$i = \frac{40 \times 0.05 \times 0.05}{10} = 0.01\text{A}$

$\therefore F = B_1 l = 40 \times 0.01 \times 0.05$

$F = 0.02\text{N}$

$\therefore W = 0.02 \times l = 0.02 \times .05$

$\therefore W = 1 \times 10^{-3}\text{J}$

Question12

The electric current in a circular coil of four turns produces a magnetic induction 32T at its centre. The coil is unwound and is rewound into a circular coil of single turn, the magnetic induction at the centre of the coil by the same current will be :

[29-Jan-2023 Shift 2]

Options:

A. 8T

B. 4T

C. 2T

D. 16T

Answer: C

Solution:

Solution:

$B = \frac{\mu_0 i}{2R} \times 4$

$B = \frac{\mu_0 i}{2R}$

$R = 4R$

$B = \frac{\mu_0 i}{8R}$

$\frac{B}{B} = \frac{1}{16}$

$B = 2\text{T}$

Question13

A massless square loop, of wire of resistance 10Ω , supporting a mass of 1g , hangs vertically with one of its sides in a uniform magnetic field of 10^3G , directed outwards in the shaded region. A dc voltage V is applied to the loop. For what value of V , the magnetic force will exactly balance the weight of the supporting mass of 1g ?

(If sides of the loop = 10cm , $g = 10\text{ms}^{-2}$)

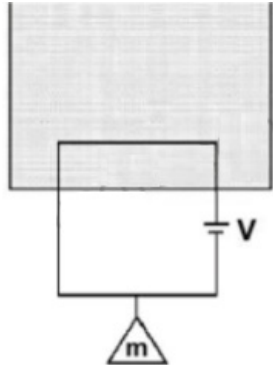

[30-Jan-2023 Shift 1]

Options:

- A. $\frac{1}{10}V$
- B. $100V$
- C. $1V$
- D. $10V$

Answer: D

Solution:

Solution:

$$F_m = mg$$

$$\therefore ILB = mg$$

$$\therefore \left(\frac{V}{R}\right)LB = mg$$

$$\therefore V = \frac{mgR}{LB}$$

$$= \frac{(1 \times 10^{-3}\text{kg})(10\text{m/s}^2)(10\Omega)}{(0.1\text{m})(10^3 \times 10^{-4}\text{T})} = 10\text{V}$$

Question 14

The magnetic moments associated with two closely wound circular coils A and B of radius $r_A = 10\text{cm}$ and $r_B = 20\text{cm}$ respectively are equal if:

(Where N_A , I_A and N_B , I_B are number of turn and current of A and B respectively)

[30-Jan-2023 Shift 1]

Options:

- A. $2N_A I_A = N_B I_B$

$$B. N_A = 2N_B$$

$$C. N_A I_A = 4N_B I_B$$

$$D. 4N_A I_A = N_B I_B$$

Answer: C

Solution:

Solution:

$$M = NIA$$

$$M_A = M_B$$

$$\therefore N_A I_A A_A = N_B I_B A_B$$

$$\therefore N_A I_A \pi (0.1)^2 = N_B I_B \pi (0.2)^2$$

$$\therefore N_A I_A = 4N_B I_B$$

Question 15

As shown in the figure, a current of 2A flowing in an equilateral triangle of side $4\sqrt{3}$ cm. The magnetic field at the centroid O of the triangle is: (Neglect the effect of earth's magnetic field.)

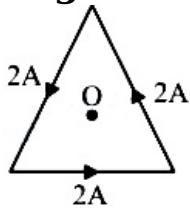

[30-Jan-2023 Shift 2]

Options:

A. $4\sqrt{3} \times 10^{-4} \text{T}$

B. $4\sqrt{3} \times 10^{-5} \text{T}$

C. $\sqrt{3} \times 10^{-4} \text{T}$

D. $3\sqrt{3} \times 10^{-5} \text{T}$

Answer: D

Solution:

Solution:

$$d \tan 60^\circ = 2\sqrt{3}$$

$$d = 2 \text{ cm}$$

$$B = 3 \times \frac{\mu_0 i}{2\pi d} \sin 60^\circ$$

$$= 3 \times \frac{2 \times 10^{-7} \times 2}{2 \times 10^{-2}} \times \frac{\sqrt{3}}{2}$$

$$= 3\sqrt{3} \times 10^{-5}$$

Question16

A current carrying rectangular loop PQRS is made of uniform wire. The length $PR = QS = 5 \text{ cm}$ and $PQ = RS = 100 \text{ cm}$. If ammeter current reading changes from I to $2I$, the ratio of magnetic forces per unit length on the wire PQ due to wire RS in the two cases respectively $f_{PQ}^I : f_{PQ}^{2I}$ is :

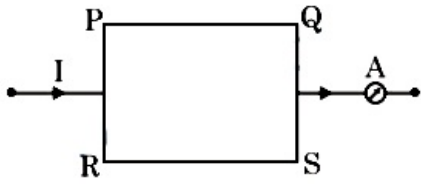

[30-Jan-2023 Shift 2]

Options:

- A. 1 : 2
- B. 1 : 4
- C. 1 : 5
- D. 1 : 3

Answer: B

Solution:

Solution:

$$F \propto I_1 I_2$$
$$F_1 : F_{21} = 1 : 4$$

Question17

A rod with circular cross-section area 2 cm^2 and length 40 cm is wound uniformly with 400 turns of an insulated wire. If a current of 0.4 A flows in the wire windings, the total magnetic flux produced inside windings is $4\pi \times 10^{-6} \text{ Wb}$. The relative permeability of the rod is (Given : Permeability of vacuum

$$\mu_0 = 4\pi \times 10^{-7} \text{ NA}^{-2})$$

[31-Jan-2023 Shift 1]

Options:

- A. 12.5
- B. $\frac{32}{5}$
- C. 125
- D. $\frac{5}{16}$



Answer: C

Solution:

$\tau = \mu_r I^2 \mu_0 l$
 $\mu_r = 125$
Option 3.

Question 18

A bar magnet with a magnetic moment 5.0 Am^2 is placed in parallel position relative to a magnetic field of 0.4 T . The amount of required work done in turning the magnet from parallel to antiparallel position relative to the field direction is _____.
[31-Jan-2023 Shift 1]

Options:

- A. 4J
- B. 1J
- C. 2J
- D. Zero

Answer: A

Solution:

Solution:
 $u = -MB \cos \theta$
 $W = \Delta u$
 $W = -MB \cos 180^\circ - (-MB \cos 0^\circ)$
 $W = 2MB = 2 \times 5 \times 0.4 = 4 \text{ J}$
Option 1

Question 19

A long conducting wire having a current I flowing through it, is bent into a circular coil of N turns. Then it is bent into a circular coil of n turns. The magnetic field is calculated at the centre of coils in both the cases. The ratio of the magnetic field in first case to that of second case is :
[31-Jan-2023 Shift 2]

Options:

- A. $N : n$

B. $n^2 : N^2$

C. $N^2 : n^2$

D. $n : N$

Answer: C

Solution:

Solution:

$$I = (2\pi r)n$$

$$r \propto \left(\frac{I}{n}\right)$$

$$B = n \left(\frac{\mu_0 i}{2r}\right) \propto \left(\frac{\mu_0 i}{2L}\right)n^2$$

$$\frac{B_1}{B_2} = \left(\frac{N^2}{n^2}\right)$$

Question20

Find the magnetic field at the point P in figure. The curved portion is a semicircle connected to two long straight wires.

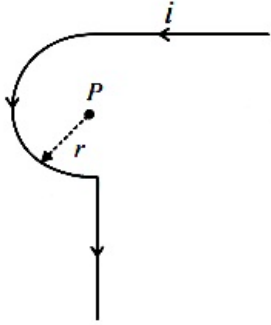

[1-Feb-2023 Shift 1]

Options:

A. $\frac{\mu_0 i}{2r} \left(1 + \frac{2}{\pi}\right)$

B. $\frac{\mu_0 i}{2r} \left(1 + \frac{1}{\pi}\right)$

C. $\frac{\mu_0 i}{2r} \left(\frac{1}{2} + \frac{1}{2\pi}\right)$

D. $\frac{\mu_0 i}{2r} \left(\frac{1}{2} + \frac{1}{\pi}\right)$

Answer: C

Solution:

Solution:

$$B_P = \left(\frac{\mu_0 i}{4r} + \frac{\mu_0 i}{4\pi r}\right) = \frac{\mu_0 i}{2r} \left(\frac{1}{2} + \frac{1}{2\pi}\right)$$

Question21

As shown in the figure, a long straight conductor with semicircular arc of radius $\pi / 10\text{m}$ is carrying current $I = 3\text{A}$. The magnitude of the magnetic field. at the center O of the arc is:

(The permeability of the vacuum $= 4\pi \times 10^{-7}\text{NA}^{-2}$)

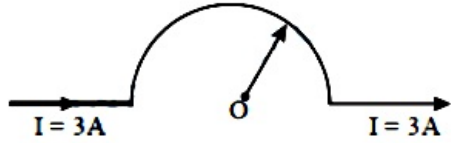

[1-Feb-2023 Shift 2]

Options:

- A. $6\mu\text{T}$
- B. $1\mu\text{T}$
- C. $4\mu\text{T}$
- D. $3\mu\text{T}$

Answer: D

Solution:

Solution:

$$\begin{aligned} B_C &= \frac{\mu_0 I}{4\pi R} (\pi) \text{ (B at centre of circular arc)} \\ &= \frac{\mu_0 I}{4R} = \frac{4\pi \times 10^{-7} \times 3}{4 \times \frac{\pi}{10}} \\ &= 3 \times 10^{-6}\text{T} = 3\mu\text{T} \end{aligned}$$

Question22

A coil is placed in magnetic field such that plane of coil is perpendicular to the direction of magnetic field. The magnetic flux through a coil can be changed:

- A. By changing the magnitude of the magnetic field within the coil.
- B. By changing the area of coil within the magnetic field.
- C. By changing the angle between the direction of magnetic field and the plane of the coil.
- D. By reversing the magnetic field direction abruptly without changing its magnitude.

Choose the most appropriate answer from the options given below:

[1-Feb-2023 Shift 2]

Options:

- A. A and B only

B. A, B and C only

C. A, B and D only

D. A and C only

Answer: B

Solution:

Solution:

$$\begin{aligned}\phi &= \vec{B} \cdot \vec{A} \\ &= BA \cdot \cos \theta\end{aligned}$$

Most suitable ans is 2 [Otherwise ABCD]

Question23

A square shaped coil of area 70cm^2 having 600 turns rotates in a magnetic field of 0.4wbm^{-2} , about an axis which is parallel to one of the side of the coil and perpendicular to the direction of field. If the coil completes 500 revolution in a minute, the instantaneous emf when the plane of the coil is inclined at 60° with the field, will be _____ V. (Take $\pi = \frac{22}{7}$)

[1-Feb-2023 Shift 2]

SOLUTION.

$$N = 600, A = 70 \times 10^{-4}\text{m}^2, B = 0.4\text{T}$$

$$\omega = \frac{500 \times 2\pi}{60} = \frac{100\pi}{6} \text{ rad / s}$$

$$E = NAB\omega \sin \omega t \quad \omega t \text{ is angle b/w } \vec{A} \& \vec{B}$$

$$= 600 \times 70 \times 10^{-4} \times 0.4 \times \frac{100\pi}{6} \times \frac{1}{2}$$

$$= 44\text{V}$$

Question24

A long straight wire of circular cross-section (radius a) is carrying steady current I. The current I is uniformly distributed across this cross-section. The magnetic field is

[6-Apr-2023 shift 1]

Options:

- A. zero in the region $r < a$ and inversely proportional to r in the region $r > a$
- B. inversely proportional to r in the region $r < a$ and uniform throughout in the region $r > a$
- C. directly proportional to r in the region $r < a$ and inversely proportional to r in the region $r > a$
- D. uniform in the region $r < a$ and inversely proportional to distance r from the axis, in the region $r > a$

Answer: C

Solution:

It is a case of solid infinite current carrying wire.

Using ampere circuital law,

CASE I: if $r \leq R$

$$B = \frac{\mu_0 i}{2\pi R^2} r$$

CASE II: $r > R$

$$B = \frac{\mu_0 i}{2\pi r}$$

Question25

Two identical circular wires of radius 20 cm and carrying current $\sqrt{2}A$ are placed in perpendicular planes as shown in figure. The net magnetic field at the centre of the circular wires is _____ $\times 10^{-8}T$.
(Take $\pi = 3.14$)

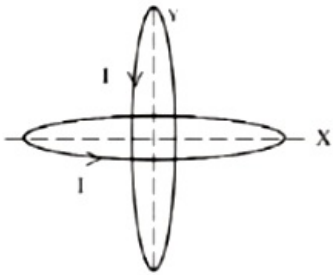

[6-Apr-2023 shift 1]

Answer: 628

Solution:

Solution:

$$\vec{B}_{net} = \frac{\mu_0 i}{2r} \hat{i} + \frac{\mu_0 i}{2r} \hat{j}$$

$$\Rightarrow B_{net} = \frac{\mu_0 i}{2r} \sqrt{2} = 4\pi \times 10^{-7} \times \sqrt{2} \times \sqrt{2} \times \frac{1}{2 \times 0.2} = 2 \times 3.14 \times 10^{-6} = 628 \times 10^{-8}T$$

Question26

A proton with a kinetic energy of 2.0 eV moves into a region of uniform magnetic field of magnitude $\frac{\pi}{2} \times 10^{-3} \text{T}$. The angle between the direction of magnetic field and velocity of proton is 60° . The pitch of the helical path taken by the proton is _____ cm.

(Take, mass of proton = $1.6 \times 10^{-27} \text{kg}$ and Charge on proton = $1.6 \times 10^{-19} \text{C}$).

[6-Apr-2023 shift 2]

Answer: 40

Solution:

Solution:

$$B = \frac{\pi}{2} \times 10^{-3}$$

$$\text{K.E.} = \frac{1}{2} m v^2$$

$$\Rightarrow v = \sqrt{\frac{2 \text{KE}}{m}}$$

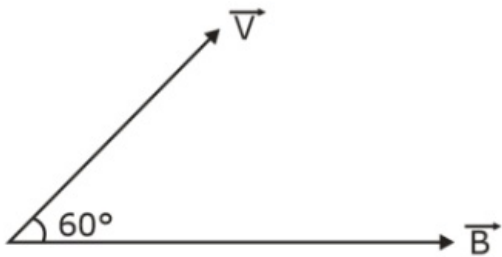

Pitch = $v \cos 60^\circ \times$ time period of one rotation

$$= v \cos 60^\circ \times \frac{2\pi m}{eB}$$

$$= \sqrt{\frac{2 \times 2 \times 1.6 \times 10^{-9}}{1.6 \times 10^{-27}}} \times \cos 60^\circ \times \frac{2\pi \times 1.6 \times 10^{-27}}{1.6 \times 10^{-19} \times \frac{\pi}{2} \times 10^{-3}}$$

$$= 2 \times 10^4 \times \frac{1}{2} \times 4 \times 10^{-5}$$

$$= 4 \times 10^{-1} \text{m} = 40 \text{cm}$$

Question27

A charge particle moving in magnetic field B , has the component velocity along B as well as perpendicular to B . The path of the particle will be

[8-Apr-2023 shift 1]



C. Helical path with the axis perpendicular to the direction of magnetic field B

D. Circular path

Answer: A

Solution:

Solution:

Path will be helical with axis along uniform \vec{B} .

Question28

The magnetic intensity at the center of a long current carrying solenoid is found to be $1.6 \times 10^3 \text{ Am}^{-1}$. If the number of turns is 8 per cm, then the current flowing through the solenoid is _____ A.

[8-Apr-2023 shift 1]

Answer: 2

Solution:

$$H = 1.6 \times 10^3 \text{ A / m}, n = 8 \text{ per cm} = 800 \text{ per m}$$

$$H = nI \Rightarrow I = \frac{H}{n}$$

$$I = \frac{1.6 \times 10^3}{8 \times 10^2} \Rightarrow I = 2 \text{ A}$$

Question29

The ratio of magnetic field at the centre of a current carrying coil of radius r to the magnetic field at distance r from the centre of coil on its axis is $\sqrt{x} : 1$. The value of x is _____.

[8-Apr-2023 shift 2]

Solution:



$$B_{\text{axis}} = \frac{\mu_0 i R^2}{2(R^2 + x^2)^{3/2}}$$

$$\frac{(B_{\text{axis}})_{x=R}}{(B_{\text{axis}})_{x=0}} = \frac{\frac{\mu_0 i R^2}{2(R^2 + R^2)^{3/2}}}{\frac{\mu_0 i R^2}{2(R^2)^{3/2}}} = \frac{R^3}{2^{3/2} R^3} = \frac{1}{\sqrt{8}}$$

$$\frac{(B)_{\text{At centre}}}{(B)_{\text{At } x=R}} = \frac{\sqrt{8}}{1}$$

$$x = 8$$

Question30

Given below are two statements :

Statements I : If the number of turns in the coil of a moving coil galvanometer is doubled then the current sensitivity becomes double.

Statements II : Increasing current sensitivity of a moving coil galvanometer by only increasing the number of turns in the coil will also increase its voltage sensitivity in the same ratio

In the light of the above statements, choose the correct answer from the options given below :

[10-Apr-2023 shift 1]

Options:

- A. Both Statement I and Statement II are true
- B. Both Statement I and Statement II are false
- C. Statement I is true but Statement II is false
- D. Statement I is false but Statement II is true

Answer: C

Solution:

Solution:

$$I = \frac{k\theta}{NBA}$$

$$C \cdot S = \frac{\theta}{I} = \frac{NBA}{K}$$

$$N \rightarrow 2N \quad C \cdot S \rightarrow 2CS$$

$$\text{But V.S.} = \frac{\theta}{V} = \frac{NBA}{KR}$$

$$N \rightarrow 2N \quad C \cdot S \rightarrow 2CS$$

$$\text{But V.S.} = \frac{\theta}{v} = \frac{\theta}{IR} = \frac{NBA}{RK}$$

As $N \rightarrow 2N$, $R \rightarrow 2R$ So V.S = constant

Question31

A straight wire carrying a current of 14A is bent into a semicircular arc of radius 2.2 cm as shown in the figure. The magnetic field produced by

the current at the centre (O) of the arc. is _____ $\times 10^{-4}T$

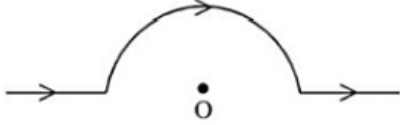

[10-Apr-2023 shift 2]

Solution:

Solution:

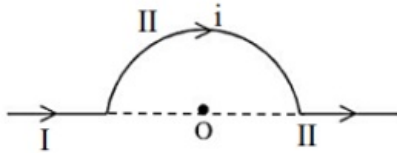

$$B_{\text{total}} = B_I + B_{II} + B_{III}$$

$$B_I = 0$$

$$B_{III} = 0$$

Because $d\vec{l} \times \vec{r} = 0$

Now, magnetic field due to semicircular ring at its center is given by

$$\begin{aligned} B_{II} &= \frac{\mu_0 i}{4R} \\ &= \frac{4\pi \times 10^{-7} \times 14}{4 \times 2.2 \times 10^{-2}} \\ &= \frac{22}{7} \times \frac{10^{-7} \times 14}{22 \times 10^{-3}} \\ &= 2 \times 10^{-7} \\ &= 2 \end{aligned}$$

Question32

An electron is allowed to move with constant velocity along the axis of current carrying straight solenoid.

- A. The electron will experience magnetic force along the axis of the solenoid.
- B. The electron will not experience magnetic force.
- C. The electron will continue to move along the axis of the solenoid.
- D. The electron will be accelerated along the axis of the solenoid.
- E. The electron will follow parabolic path-inside the solenoid.

Choose the correct answer from the options given below:

[11-Apr-2023 shift 2]

Options:

- A. A and D only
- B. B, C and D only
- C. B and E only

D. B and C only

Answer: D

Solution:

Solution:

We know that

In the solenoid magnetic field along the axis of solenoid.

When charge particle moving inside solenoid along the axis $F = 0$

$$\vec{F}_m = q(\vec{V} \times \vec{B})$$

$$\text{So, } \vec{F}_m = 0$$

And it moves with constant velocity.

Question33

An electron is moving along the positive x-axis. If the uniform magnetic field is applied parallel to the negative z-axis, then

- A. The electron will experience magnetic force along positive y-axis**
 - B. The electron will experience magnetic force along negative y-axis**
 - C. The electron will not experience any force in magnetic field**
 - D. The electron will continue to move along the positive x-axis**
 - E. The electron will move along circular path in magnetic field**
- Choose the correct answer from the options given below :**

[13-Apr-2023 shift 2]

Options:

- A. B and E only
- B. A and E only
- C. B and D only
- D. C and D only

Answer: A

Solution:

Solution:

$$\vec{F} = q(\vec{V} \times \vec{B})$$

$$\vec{F} = -e(\vec{V} \times \vec{B})$$

Force will be along -ve yaxis As magnetic force is \perp_r to velocity, path of electron must be circle.

Question34

A straight wire AB of mass 40g and length 50 cm is suspended by a pair of flexible leads in uniform magnetic field of magnitude 0.40T as shown in the figure. The magnitude of the current required in the wire to

remove the tension in the supporting leads is _____ A. (. Take $g = 10\text{ms}^{-2}$)

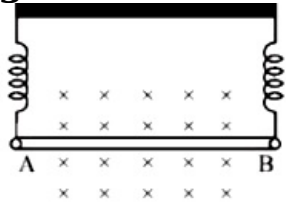

[13-Apr-2023 shift 2]

Answer: 2

Solution:

Solution:

For equilibrium :

$$Mg = I l B$$

$$I = \frac{Mg}{lB} = \frac{40 \times 10^{-3} \times 10}{50 \times 10^{-2} \times 0.4} = 2\text{A}$$

Question35

An electron in a hydrogen atom revolves around its nucleus with a speed of $6.76 \times 10^6 \text{ms}^{-1}$ in an orbit of radius 0.52\AA . The magnetic field produced at the nucleus of the hydrogen atom is _____ T.

[15-Apr-2023 shift 1]

SOLUTION:

Biot-Savart law,

$$B = \frac{\mu_0}{4\pi} \times \frac{qV}{r^2}$$

$$B = 10^{-7} \times \frac{1.6 \times 10^{-19} \times 6.76 \times 10^6}{(0.52 \times 10^{-10})^2}$$

$$B = 40\text{T}$$

Question36

Given below are two statements : One is labelled as Assertion (A) and the other is labelled as Reason (R).

Assertion (A): In an uniform magnetic field, speed and energy remains

the same for a moving charged particle.

Reason (R): Moving charged particle experiences magnetic force perpendicular to its direction of motion.

[24-Jun-2022-Shift-1]

Options:

- A. Both (A) and (R) are true and (R) is the correct explanation of (A).
- B. Both (A) and (R) are true but (R) is NOT the correct explanation of (A).
- C. (A) is true but (R) is false.
- D. (A) is false but (R) is true.

Answer: A

Solution:

Solution:

Magnetic force $\vec{F} \perp \vec{v}$

$\Rightarrow W_b = 0$

$\Rightarrow \Delta K E = 0$ and speed remains constant.

Question37

The magnetic field at the centre of a circular coil of radius r , due to current I flowing through it, is B . The magnetic field at a point along the axis at a distance $\frac{r}{2}$ from the centre is :

[24-Jun-2022-Shift-1]

Options:

- A. $B / 2$
- B. $2B$
- C. $\left(\frac{2}{\sqrt{5}} \right)^3 B$
- D. $\left(\frac{2}{\sqrt{3}} \right)^3 B$

Answer: C

Solution:

Solution:

$$B = \frac{\mu_0 I}{2r}$$

$$B_a = \frac{\mu_0 I r^2}{2 \left(r^2 + \frac{r^2}{4} \right)}$$



$$\Rightarrow \frac{B_a}{B} = \left(\frac{2}{\sqrt{5}} \right)^3$$
$$\Rightarrow B_a = \left(\frac{2}{\sqrt{5}} \right)^3 B$$

Question38

A proton, a deuteron and an α -particle with same kinetic energy enter into a uniform magnetic field at right angle to magnetic field. The ratio of the radii of their respective circular paths is :
[24-Jun-2022-Shift-2]

Options:

A. $1 : \sqrt{2} : \sqrt{2}$

B. $1 : 1 : \sqrt{2}$

C. $\sqrt{2} : 1 : 1$

D. $1 : \sqrt{2} : 1$

Answer: D

Solution:

$$\therefore r = \frac{mv}{qB} = \frac{\sqrt{2m(KE)}}{qB}$$
$$\Rightarrow r_1 : r_2 : r_3 = \frac{\sqrt{m_1}}{q_1} : \frac{\sqrt{m_2}}{q_2} : \frac{\sqrt{m_3}}{q_3}$$
$$= \frac{\sqrt{1}}{1} : \frac{\sqrt{2}}{1} : \frac{\sqrt{4}}{2}$$
$$= 1 : \sqrt{2} : 1$$

Question39

A long straight wire with a circular cross-section having radius R, is carrying a steady current I. The current I is uniformly distributed across this cross-section. Then the variation of magnetic field due to current I with distance r ($r < R$) from its centre will be :
[25-Jun-2022-Shift-1]

Options:

A. $B \propto r^2$

B. $B \propto r$

C. $B \propto \frac{1}{r^2}$

D. $B \propto \frac{1}{r}$

Answer: B

Solution:

$$\int \vec{B} \cdot d\vec{l} = \mu_0 I_{in}$$
$$\Rightarrow B \times 2\pi r = \frac{\mu_0 I}{\pi R^2} \times \pi r^2$$
$$\Rightarrow B \propto r$$

Question40

A long solenoid carrying a current produces a magnetic field B along its axis. If the current is doubled and the number of turns per cm is halved, the new value of magnetic field will be equal to [25-Jun-2022-Shift-2]

Options:

- A. B
- B. 2B
- C. 4B
- D. $\frac{B}{2}$

Answer: A

Solution:

Solution:

$$B = \mu_0 ni$$

Now $i \rightarrow 2i$

And $n \rightarrow \frac{n}{2}$

$$B' = \mu_0 \frac{n}{2} \times 2i = \mu_0 ni = B$$

Question41

A proton and an alpha particle of the same velocity enter in a uniform magnetic field which is acting perpendicular to their direction of motion. The ratio of the radii of the circular paths described by the alpha particle and proton is : [26-Jun-2022-Shift-1]

Options:

- A. 1 : 4
- B. 4 : 1

C. 2 : 1

D. 1 : 2

Answer: C

Solution:

Solution:

$$R = \frac{mv}{qB}$$
$$\frac{R_\alpha}{R_p} = \frac{M_\alpha}{M_p} \times \frac{q_p}{q_\alpha}$$
$$\frac{R_\alpha}{R_p} = \frac{4}{1} \times \frac{1}{2} = 2$$

Question42

A bar magnet having a magnetic moment of $2.0 \times 10^5 \text{JT}^{-1}$, is placed along the direction of uniform magnetic field of magnitude $B = 14 \times 10^{-5} \text{ T}$. The work done in rotating the magnet slowly through 60° from the direction of field is :

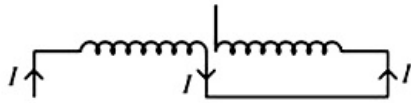

[26-Jun-2022-Shift-2]

Options:

A. 14J

B. 8.4J

C. 4J

D. 1.4J

Answer: A

Solution:

Solution:

$$U = -\vec{M} \cdot \vec{B}$$
$$\text{So } U_f - U_i = -MB(1 - \cos \theta)$$
$$= -14\text{J}$$
$$\text{So } W = -\Delta U = 14\text{J}$$

Question43

A metal surface is illuminated by a radiation of wavelength 4500\AA . The ejected photo-electron enters a constant magnetic field of 2 mT making

an angle of 90° with the magnetic field. If it starts revolving in a circular path of radius 2 mm, the work function of the metal is approximately :

[26-Jun-2022-Shift-2]

Options:

- A. 1.36 eV
- B. 1.69 eV
- C. 2.78 eV
- D. 2.23 eV

Answer: A

Solution:

Solution:

$$\frac{hc}{\lambda} - \phi = K E \dots\dots (i)$$

$$R = \frac{mv}{Bq} = \frac{\sqrt{2m(KE)}}{Bq} \dots\dots (ii)$$

Putting the values,
 $\phi \approx 1.36 \text{ eV}$

Question44

Two 10 cm long, straight wires, each carrying a current of 5A are kept parallel to each other. If each wire experienced a force of 10^{-5} N , then separation between the wires is _____ cm.

[26-Jun-2022-Shift-2]

Solution:

$$\frac{dF}{dl} = \frac{\mu_0 i_1 i_2}{2\pi d}$$
$$10^{-5} = \frac{10^{-7} \times 5 \times 5}{2\pi d}$$
$$d = \frac{10^{-5} \times 2\pi}{10^{-7} \times 5 \times 5}$$

$$d = \frac{2 \times 10^{-7} \times 5 \times 5}{10^{-4}}$$

$$= 50 \text{ mm}$$

$$= 5 \text{ cm}$$

Question45

Two long parallel conductors S_1 and S_2 are separated by a distance 10 cm and carrying currents of 4A and 2A respectively. The conductors are placed along X-axis in X – Y plane. There is a point P located between the conductors (as shown in figure).

A charge particle of 3π coulomb is passing through the point P with velocity $\vec{v} = (2\hat{i} + 3\hat{j})$ m / s; where \hat{i} and \hat{j} represents unit vector along x&y axis respectively.

The force acting on the charge particle is $4\pi \times 10^{-5} (-x\hat{i} + 2\hat{j})$ N. The value of x is :

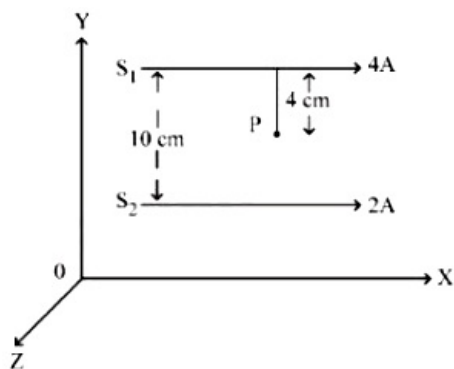

[27-Jun-2022-Shift-2]

Options:

- A. 2
- B. 1
- C. 3
- D. -3

Answer: C

Solution:

Solution:

$$\text{Field at P is } = \left(\frac{\mu_0 \times i_1}{2\pi r_1} - \frac{\mu_0 i_2}{2\pi r_2} \right) (-\hat{k})$$

$$= - \left(\frac{\mu_0 \times 4}{2\pi \times 0.04} - \frac{\mu_0 \times 2}{2\pi \times 0.06} \right) \hat{k} = - \frac{\mu_0 \times 200}{6\pi} \hat{k}$$

So, force $\vec{F} = q\vec{v} \times \vec{B}$

$$= 3\pi (2\hat{i} + 3\hat{j}) \times \left(- \left(\frac{\mu_0 \times 200}{6\pi} \right) \hat{k} \right)$$

$$= 3\pi \left(\frac{200\mu_0}{3\pi} \hat{j} - \frac{100\mu_0}{\pi} \hat{i} \right)$$

$$= 200\mu_0 \hat{j} - 300\mu_0 \hat{i}$$

$$= 4\pi \times 10^{-5} (2\hat{j} - 3\hat{i})$$

So, x = 3

Question46

A deuteron and a proton moving with equal kinetic energy enter into a

uniform magnetic field at right angle to the field. If r_d and r_p are the radii of their circular paths respectively, then the ratio $\frac{r_d}{r_p}$ will be $\sqrt{x} : 1$ where x is _____
 [27-Jun-2022-Shift-2]

Solution:

Solution:

$$R = \frac{\sqrt{2mK}}{qB}$$

$$\text{So, } \frac{r_d}{r_p} = \frac{\sqrt{m_d} / q_d}{\sqrt{m_p} / q_p}$$

$$= \sqrt{2}$$

$$\text{So } x = 2$$

Question47

An infinitely long hollow conducting cylinder with radius R carries a uniform current along its surface.

Choose the correct representation of magnetic field (B) as a function of radial distance (r) from the axis of cylinder.

[28-Jun-2022-Shift-1]

Options:

A.

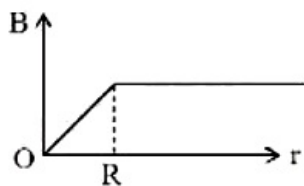

B.

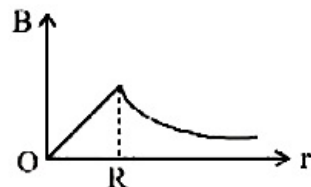

C.

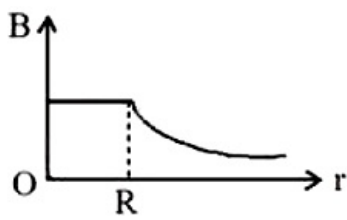

D.

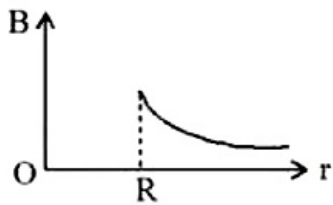

Answer: D

Solution:

Solution:

Inside a hollow cylindrical conductor with uniform current distribution net magnetic field is zero in hollow space.

But outside the cylindrical conductor $B \propto \frac{1}{r}$

⇒ Graph in option D would be a correct one

Question48

A singly ionized magnesium atom ($A = 24$) ion is accelerated to kinetic energy 5 keV, and is projected perpendicularly into a magnetic field B of the magnitude 0.5T. The radius of path formed will be ____ cm. [28-Jun-2022-Shift-1]

Solution:

$$R = \frac{mv}{qB}$$

$$R = \frac{\sqrt{2mKE}}{qB}$$

$$= \frac{\sqrt{2 \times 24 \times 1.67 \times 10^{-27} \times 5 \times 1.6 \times 10^{-16}}}{1.6 \times 10^{-19} \times 0.5}$$

$$= 10.009 \text{ cm} = 10 \text{ cm}$$

Question49

Two parallel, long wires are kept 0.20m apart in vacuum, each carrying

current of x A in the same direction. If the force of attraction per meter of each wire is 2×10^{-6} N, then the value of x is approximately :
[28-Jun-2022-Shift-2]

Options:

- A. 1
- B. 2.4
- C. 1.4
- D. 2

Answer: C

Solution:

Solution:

$$\frac{dF}{dl} = 2 \times 10^{-6} \text{N/m} = \frac{\mu_0 i_1 i_2}{2\pi d}$$

$$2 \times 10^{-6} = \frac{2 \times 10^{-7} \times x^2}{0.2}$$

$$x = \sqrt{2} \approx 1.4$$

Question50

A coil is placed in a time varying magnetic field. If the number of turns in the coil were to be halved and the radius of wire doubled, the electrical power dissipated due to the current induced in the coil would be :

(Assume the coil to be short circuited.)

[28-Jun-2022-Shift-2]

Options:

- A. Halved
- B. Quadrupled
- C. The same
- D. Doubled

Answer: B

Solution:

Solution:

As number of turns are halved so length of wire is halved, and radius is doubled, then area will be 4 times the previous one if previous resistance is R then new resistance is $\frac{R}{8}$ and if previous emf is E then new emf will be $\frac{E}{2}$ so

$$P_i = \frac{E^2}{R}$$

$$P_f = \frac{(E/2)^2}{R/8} = \frac{2E^2}{R} = 2P_i$$



Question51

A charge particle moves along circular path in a uniform magnetic field in a cyclotron. The kinetic energy of the charge particle increases to 4 times its initial value. What will be the ratio of new radius to the original radius of circular path of the charge particle :
[29-Jun-2022-Shift-1]

Options:

- A. 1 : 1
- B. 1 : 2
- C. 2 : 1
- D. 1 : 4

Answer: C

Solution:

Solution:

$$R = \frac{mv}{Bq} = \frac{\sqrt{2mK}}{Bq}$$

$$\Rightarrow R \propto \sqrt{K}$$

$$\Rightarrow \text{ratio} = 2 : 1$$

Question52

Two long current carrying conductors are placed parallel to each other at a distance of 8 cm between them. The magnitude of magnetic field produced at mid-point between the two conductors due to current flowing in them is $300\mu\text{T}$. The equal current flowing in the two conductors is:
[29-Jun-2022-Shift-2]

Options:

- A. 30A in the same direction.
- B. 30A in the opposite direction.
- C. 60A in the opposite direction.
- D. 300A in the opposite direction.

Answer: B

Solution:



As $B_{\text{net}} \neq 0$ that is the wires are carrying current in opposite direction.

$$\frac{\mu_0 I \times 2}{2\pi(4 \times 10^{-2})} = 30 \times 10^{-6} \text{T}$$

$$\Rightarrow I = \frac{30 \times 10^{-6}}{10^{-6}} \text{A} = 30 \text{A} \text{ in opposite direction.}$$

Question53

Two charged particles, having same kinetic energy, are allowed to pass through a uniform magnetic field perpendicular to the direction of motion. If the ratio of radii of their circular paths is 6 : 5 and their respective masses ratio is 9 : 4. Then, the ratio of their charges will be : [25-Jul-2022-Shift-1]

Options:

- A. 8 : 5
- B. 5 : 4
- C. 5 : 3
- D. 8 : 7

Answer: B

Solution:

Solution:

$$\text{We know that } R = \frac{mv}{Bq} = \sqrt{\frac{2mK}{Bq}}$$

$$\Rightarrow \text{Ratio of radii} = \frac{R_1}{R_2} = \sqrt{\frac{m_1 q_2}{m_2 q_1}}$$

$$\Rightarrow \frac{6}{5} = \sqrt{\frac{9}{4} \frac{q_2}{q_1}}$$

$$\Rightarrow \frac{q_1}{q_2} = \frac{3}{2} \times \frac{5}{6} = \frac{5}{4}$$

Question54

The electric current in a circular coil of 2 turns produces a magnetic induction B_1 at its centre. The coil is unwound and in rewound into a circular coil of 5 turns and the same current produces a magnetic induction B_2 at its centre. The ratio of $\frac{B_2}{B_1}$ is

[25-Jul-2022-Shift-2]

Options:

- A. $\frac{5}{2}$



B. $\frac{25}{4}$

C. $\frac{5}{4}$

D. $\frac{25}{2}$

Answer: B

Solution:

Solution:

$$B = \frac{n\mu_0 I}{2R}$$

$$B_1 = \frac{2\mu_0 I}{2R_1}$$

$$B_2 = \frac{5\mu_0 I}{2R_2}$$

$$R_2 = \frac{2R_1}{5}$$

$$\Rightarrow \frac{B_2}{B_1} = \frac{5}{2} \times \frac{R_1}{R_2} = \frac{25}{4}$$

Question55

A charge particle is moving in a uniform magnetic field $(2\hat{i} + 3\hat{j})\text{T}$. If it has an acceleration of $(\alpha\hat{i} - 4\hat{j})\text{m/s}^2$, then the value of α will be :
[26-Jul-2022-Shift-1]

Options:

A. 3

B. 6

C. 12

D. 2

Answer: B

Solution:

Solution:

As magnetic force is perpendicular to magnetic field

So, $\vec{F} \cdot \vec{B}$ must be 0

So, $2\alpha - 12 = 0$

$\alpha = 6$

Question56

B_X and B_Y are the magnetic fields at the centre of two coils X and Y respectively each carrying equal current. If coil X has 200 turns and 20 cm radius and coil Y has 400 turns and 20 cm radius, the ratio of B_X and B_Y is :

[26-Jul-2022-Shift-1]

Options:

- A. 1 : 1
- B. 1 : 2
- C. 2 : 1
- D. 4 : 1

Answer: B

Solution:

Solution:

$$B = \frac{\mu_0 N I}{2R}$$

$$\frac{B_X}{B_Y} = \frac{N_x R_y}{N_y R_x}$$

$$= \frac{200 \times 20}{400 \times 20} = \frac{1}{2}$$

Question57

Two concentric circular loops of radii $r_1 = 30$ cm and $r_2 = 50$ cm are placed in X – Y plane as shown in the figure. A current $I = 7$ A is flowing through them in the direction as shown in figure. The net magnetic moment of this system of two circular loops is approximately :

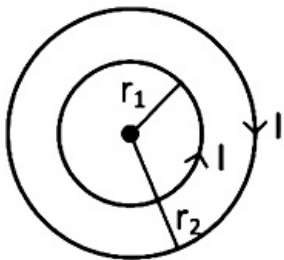

[26-Jul-2022-Shift-2]

Options:

- A. $\frac{7}{2} \hat{k} \text{Am}^2$
- B. $-\frac{7}{2} \hat{k} \text{Am}^2$
- C. $7 \hat{k} \text{Am}^2$
- D. $-7 \hat{k} \text{Am}^2$

Answer: B

Solution:

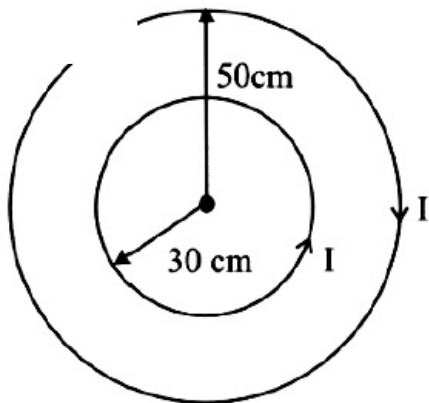

Magnetic moment

$$\begin{aligned}\vec{M} &= -i\pi(0.5)^2\hat{k} + i\pi(0.3)^2\hat{k} \\ \vec{M} &= -7 \times \frac{22}{7} \left(\frac{25}{100} - \frac{9}{100} \right) \hat{k} \\ &= -22 \left(\frac{16}{100} \right) \hat{k} \\ \vec{M} &= -3.52\hat{k}\text{Am}^2 \\ &= -\frac{7}{2}\hat{k}\text{Am}^2\end{aligned}$$

Question58

A cyclotron is used to accelerate protons. If the operating magnetic field is 1.0T and the radius of the cyclotron 'dees' is 60 cm, the kinetic energy of the accelerated protons in MeV will be :

[use $m_p = 1.6 \times 10^{-27}$ kg, $e = 1.6 \times 10^{-19}$ C]

[27-Jul-2022-Shift-2]

Options:

- A. 12
- B. 18
- C. 16
- D. 32

Answer: B

Solution:

Solution:

Kinetic energy of electron in cyclotron

$$\begin{aligned}&= \left[\frac{q^2 B^2 r_0^2}{2m} \right] \\ &= 18 \text{ MeV}\end{aligned}$$

Question59

The current sensitivity of a galvanometer can be increased by :

- (A) decreasing the number of turns
- (B) increasing the magnetic field
- (C) decreasing the area of the coil
- (D) decreasing the torsional constant of the spring

Choose the most appropriate answer from the options given below :
[28-Jul-2022-Shift-1]

Options:

- A. (B) and (C) only
- B. (C) and (D) only
- C. (A) and (C) only
- D. (B) and (D) only

Answer: D

Solution:

$$\Rightarrow \frac{\theta}{i} = \frac{NAB}{k}$$

⇒ Sensitivity increases if $B \uparrow$ and $k \downarrow$

Question60

A uniform electric field $E = (8m / e)V / m$ is created between two parallel plates of length 1m as shown in figure, (where $m =$ mass of electron and $e =$ charge of electron). An electron enters the field symmetrically with a speed of $2m / s$. The angle of the deviation (θ) of the path of the electron as it comes out of the field will be _____.

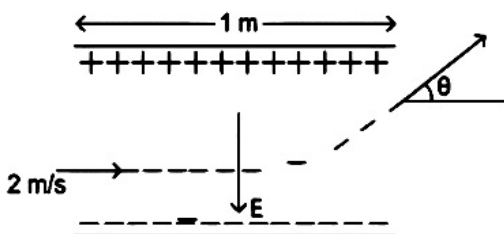

[28-Jul-2022-Shift-2]

Options:

- A. $\tan^{-1}(4)$
- B. $\tan^{-1}(2)$

C. $\tan^{-1}\left(\frac{1}{3}\right)$

D. $\tan^{-1}(3)$

Answer: B

Solution:

Solution:

$$E = \frac{8m}{e}V / m$$

$$l = 1m$$

$$v_x = 2m / s$$

$$a_y = -8m / s^2$$

$$t = \frac{l}{v_x} = \frac{1}{2}s$$

$$\Rightarrow |v_y| = 4m / s$$

$$\Rightarrow \text{angle of deviation} = \theta$$

$$\tan \theta = \frac{v_y}{v_x}$$

$$\theta = \tan^{-1}\left(\frac{4}{2}\right) = \tan^{-1}(2)$$

Question61

A triangular shaped wire carrying 10A current is placed in a uniform magnetic field of 0.5T, as shown in figure. The magnetic force on segment CD is

(Given $BC = CD = BD = 5 \text{ cm}$.)

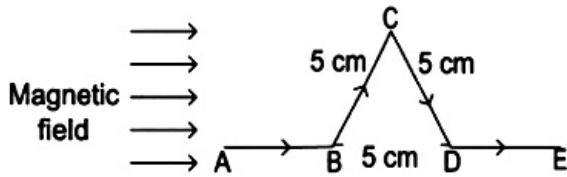

[28-Jul-2022-Shift-2]

Options:

A. 0.126N

B. 0.312N

C. 0.216N

D. 0.245N

Answer: C

Solution:

Solution:

$$\vec{F} = i\vec{l} \times \vec{B}$$

$$= il B \sin 60^\circ$$

$$= 10 \times \frac{5}{100} \times 0.5 \times \frac{\sqrt{3}}{2}$$

$$= 0.2165\text{N}$$

Question62

A closely wound circular coil of radius 5 cm produces a magnetic field of $37.68 \times 10^{-4}\text{T}$ at its center. The current through the coil is _____ A. [Given, number of turns in the coil is 100 and $\pi = 3.14$]
[29-Jul-2022-Shift-1]

Solution:

$$B = \frac{\mu_0 n I}{2R}$$

$$37.68 \times 10^{-4} = \frac{4\pi \times 10^{-7} 100 I}{2 \times 5 \times 10^{-2}}$$

$$I = \frac{300\text{A}}{100}$$
$$= 3\text{A}$$

Question63

Magnetic fields at two points on the axis of a circular coil at a distance of 0.05m and 0.2m from the centre are in the ratio 8 : 1. The radius of coil is
[25 Feb 2021 Shift 1]

Options:

- A. 0.2m
- B. 0.1m
- C. 0.15m
- D. 1.0m

Answer: B

Solution:

Solution:

Given, $d_1 = 0.05\text{m}$, $d_2 = 0.2\text{m}$

and $B_1 : B_2 = 8 : 1$

Let radius of coil be r.

As we know that, magnetic field at a point on axis of a coil,



$$B = \frac{\mu_0}{2} \cdot \frac{I r^2}{(d_1^2 + r^2)^{3/2}}$$

$$\therefore \frac{B_1}{B_2} = \frac{r^2 \cdot (d_2^2 + r^2)^{3/2}}{(d_1^2 + r^2)^{3/2} \cdot r^2} = \frac{(d_2^2 + r^2)^{3/2}}{(d_1^2 + r^2)^{3/2}}$$

$$\frac{8}{1} = \left(\frac{d_2^2 + r^2}{d_1^2 + r^2} \right)^{3/2} \Rightarrow \frac{2^3}{1} = \left(\frac{d_2^2 + r^2}{d_1^2 + r^2} \right)^{3/2}$$

$$\frac{4}{1} = \frac{d_2^2 + r^2}{d_1^2 + r^2}$$

$$\Rightarrow 4d_1^2 + 4r^2 = d_2^2 + r^2$$

$$\Rightarrow 4(0.05)^2 + 4r^2 = (0.2)^2 + r^2 \Rightarrow 3r^2 = 0.03$$

$$\Rightarrow r = 0.1\text{m}$$

Question64

A proton, a deuteron and an alpha-particle are moving with same momentum in a uniform magnetic field. The ratio of magnetic forces acting on them is and their speed is in the ratio.
[25 Feb 2021 Shift 1]

Options:

- A. 1 : 2 : 4 and 2 : 1 : 1
- B. 2 : 1 : 1 and 4 : 2 : 1
- C. 4 : 2 : 1 and 2 : 1 : 1
- D. 1 : 2 : 4 and 1 : 1 : 2

Answer: B

Solution:

Solution:

Let F_p , F_d and F_α be the forces and v_p , v_d and v_α be the velocities of proton, deuteron and α -particle, respectively.

Since, $F = Bqv$

On dividing and multiplying F by m , we get

$$F = Bqv \frac{m}{m}$$

$$\Rightarrow F = B \frac{q}{m} p \quad (\because p = mv)$$

$$\Rightarrow F \propto q / m \quad (\because p \text{ and } B \text{ are same})$$

$$\therefore F_p : F_d : F_\alpha = \frac{+q}{m} : \frac{+q}{2m} : \frac{+2q}{4m}$$

$$= 1 : 1/2 : 1/2 = 2 : 1 : 1$$

$$\text{and } = Bqv$$

$$\Rightarrow \propto F / q$$

$$\therefore v_p : v_d : v_\alpha = \frac{F_p}{q_p} : \frac{F_d}{q_d} : \frac{F_\alpha}{q_\alpha} = \frac{2x}{q} : \frac{x}{q} : \frac{x}{2q}$$

$$= 2 : 1 : 1/2 = 4 : 2 : 1$$

Question65

Four identical long solenoids A, B, C and D are connected to each other as shown in the figure. If the magnetic field at the centre of A is 3T, the



field at the centre of C would be (Assume that, the magnetic field is confined with in the volume of respective solenoid)

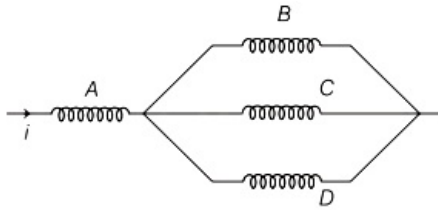

[18 Mar 2021 Shift 1]

Options:

- A. 12T
- B. 6T
- C. 9T
- D. 1T

Answer: D

Solution:

Solution:

Given, magnetic field at the centre at A is 3T .
 Since, the solenoid B, C and D are connected in parallel arrangement.

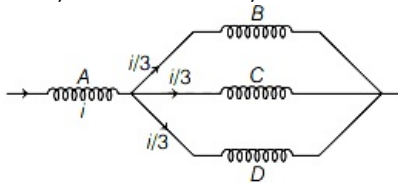

We know that,
 The magnetic field in the circuit is directly proportional to the
 $B \propto i$

$$\Rightarrow \frac{B_A}{B_C} = \frac{I_A}{I_C} \Rightarrow \frac{3T}{B_C} = \frac{i}{i/3}$$

$$\Rightarrow B_C = 1T$$

So, the field at the centre at C = 1T .

Question66

A hairpin like shape as shown in figure is made by bending a long current carrying wire. What is the magnitude of a magnetic field at point P which lies on the centre of the semicircle?

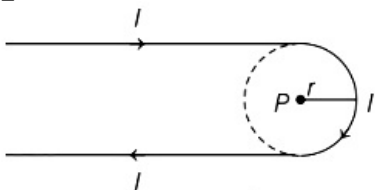

[17 Mar 2021 Shift 2]

Options:

- A. $\frac{\mu_0 I}{4\pi r} (2 - \pi)$

B. $\frac{\mu_0 I}{4\pi r}(2 + \pi)$

C. $\frac{\mu_0 I}{2\pi r}(2 + \pi)$

D. $\frac{\mu_0 I}{2\pi r}(2 - \pi)$

Answer: B

Solution:

Solution:

For the straight wire, the expression of the magnetic field,

$$B_1 = B_3 = \frac{\mu_0 I}{4\pi r}$$

For the semicircular wire, the expression of the magnetic field,

$$B_2 = \frac{\mu_0 I}{4r}$$

Hence, the total magnetic field at the point P, $B = B_1 + B_2 + B_3$

Substituting the values in the above equation, we get

$$B = \frac{\mu_0 I}{4\pi r} + \frac{\mu_0 I}{4r} + \frac{\mu_0 I}{4\pi r} \Rightarrow B = \frac{\mu_0 I}{4\pi r}(1 + 1 + \pi)$$

$$B = \frac{\mu_0 I}{4\pi r}(2 + \pi)$$

Question67

A proton and an α -particle, having kinetic energies K_p and K_α , respectively, enter into a magnetic field at right angles.

The ratio of the radii of trajectory of proton to that of α -particle is 2 : 1.

The ratio of $K_p : K_\alpha$ is

[18 Mar 2021 Shift 2]

Options:

A. 1 : 8

B. 8 : 1

C. 1 : 4

D. 4 : 1

Answer: D

Solution:

Solution:

Given, the charge on the proton, $q_p = +e$

The charge on the alpha particles, $q_\alpha = +2e$

The expression of the radius of the orbit,

$$r = \frac{mv}{qB}$$

$$\Rightarrow r = \frac{p}{qB} \quad (\because p = mv)$$

$$\therefore \frac{r_p}{r_\alpha} = \frac{p_p}{q_p} \times \frac{q_\alpha}{p_\alpha}$$

$$\Rightarrow \frac{2}{1} = \frac{+2e}{+e} \times \frac{p_p}{p_\alpha}$$

$$\left[\because \frac{r_p}{r_\alpha} = \frac{2}{1} \right]$$

$$\Rightarrow \frac{p_p}{p_\alpha} = 1$$

Since, kinetic energy and momentum are related as

$$K = \frac{p^2}{2m}$$

$$\therefore \frac{K_p}{K_\alpha} = \frac{p_p^2 m_\alpha}{m_p p_\alpha^2} \Rightarrow \frac{K_p}{K_\alpha} = \frac{m_\alpha}{m_p} = \frac{4m_p}{m_p}$$

$$\Rightarrow \frac{K_p}{K_\alpha} = \frac{4}{1}$$

Question68

A charge Q is moving d l distance in the magnetic field B. Find the value of work done by B.

[16 Mar 2021 Shift 2]

Options:

- A. 1
- B. Infinite
- C. Zero
- D. -1

Answer: C

Solution:

Solution:

According to question, a charge Q is moving d distance in magnetic field B.

As we know that force acting on a point charge by magnetic field is always perpendicular to the velocity of particle v.

$$\therefore F = Q(v \times B) \dots (i)$$

The above, statement means that F is perpendicular to v.

$$\therefore \text{Work done, } W = F \cdot ds$$

$$= Q(v \times B) \cdot dl \quad [\text{using Eq. (i)}]$$

$$= Q(v \times B) dl \cos \theta$$

$$= Q(v \times B) dl \cos 90^\circ \quad [\because \theta = 90^\circ \text{ } F \perp v \text{ or } dl]$$

$$= 0$$

\(\therefore\) The work done by the magnetic field will be zero.

Question69

A loop of flexible wire of irregular shape carrying current is placed in an external magnetic field.

Identify the effect of the field on the wire.



[18 Mar 2021 Shift 1]

Options:

- A. Loop assumes circular shape with its plane normal to the field.
- B. Loop assumes circular shape with its plane parallel to the field.
- C. Wire gets stretched to become straight.
- D. Shape of the loop remains unchanged.

Answer: A

Solution:

Solution:

A loop of wire will act like magnetic dipole. In equilibrium, direction of dipole will be parallel to direction of magnetic field and its plane remains normal to the field.

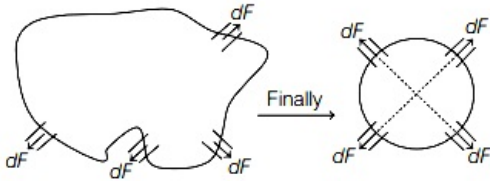

Now on each element of wire force due to magnetic field will be perpendicular to length of element and outward in direction. So, loop will become circular. Hence, the correct option is (a).

Question70

Figure A and B shown two long straight wires of circular cross-section (a and b with $a < b$), carrying current I which is uniformly distributed across the cross-section. The magnitude of magnetic field B varies with radius r and can be represented as :

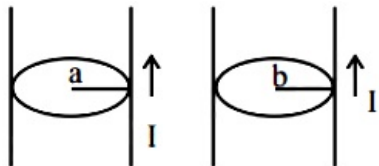

Fig. A

Fig. B

[27 Jul 2021 Shift 2]

Options:

A.

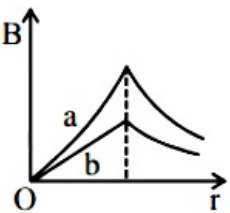

B.



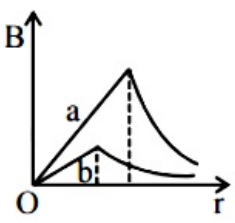

C.

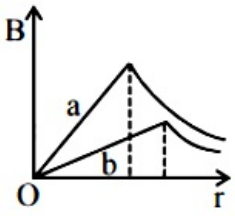

D.

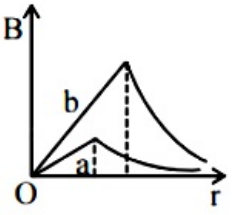

Answer: C

Solution:

Solution:

Graph for wire of radius R :

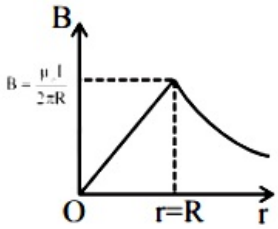

As $b > a$

$B_a > B_b$

$$B_a = \frac{\mu_0 i}{2\pi a}$$

$$B_b = \frac{\mu_0 i}{2\pi b}$$

Question 71

Match List I with List II.

List-I	List-II
(a) Capacitance, C	(i) $M^1L^1T^{-3}A^{-1}$
(b) Permittivity of free space, ϵ_0	(ii) $M^{-1}L^{-3}T^4A^2$
(c) Permeability of free space, μ_0	(iii) $M^{-1}L^{-2}T^4A^2$
(d) Electric field, E	(iv) $M^1L^1T^{-2}A^{-2}$

**Choose the correct answer from the options given below
[27 Jul 2021 Shift 2]**

Options:

- A. (a) \rightarrow (iii), (b) \rightarrow (ii), (c) \rightarrow (iv), (d) \rightarrow (i)
 B. (a) \rightarrow (iii), (b) \rightarrow (iv), (c) \rightarrow (ii), (d) \rightarrow (i)
 C. (a) \rightarrow (iv), (b) \rightarrow (ii), (c) \rightarrow (iii), (d) \rightarrow (i)
 D. (a) \rightarrow (iv), (b) \rightarrow (iii), (c) \rightarrow (ii), (d) \rightarrow (i)

Answer: A

Solution:

Solution:

$$q = CV$$

$$[C] = \left[\frac{q}{V} \right] = \frac{(A \times T)^2}{ML^2T^{-2}}$$

$$= M^{-1}L^{-2}T^4A^2$$

$$[E] = \left[\frac{F}{q} \right] = \frac{MLT^{-2}}{AT}$$

$$= MLT^{-3}A^{-1}$$

$$F = \frac{q_1q_2}{4\pi\epsilon_0 r^2}$$

$$[\epsilon_0] = M^{-1}L^{-3}T^4A^2$$

$$\text{Speed of light } c = \frac{1}{\sqrt{\mu_0\epsilon_0}}$$

$$\mu_0 = \frac{1}{\epsilon_0 c^2}$$

$$[\mu_0] = \frac{1}{[M^{-1}L^{-3}T^4A^2][LT^{-1}]^2}$$

$$= [M^1L^1T^{-2}A^{-2}]$$

Question72

**Two ions having same mass have charges in the ratio 1 : 2. They are projected normally in a uniform magnetic field with their speeds in the ratio 2 : 3. The ratio of the radii of their circular trajectories is :
[25 Jul 2021 Shift 2]**

Options:

- A. 1 : 4

- B. 4 : 3
- C. 3 : 1
- D. 2 : 3

Answer: B

Solution:

Solution:

$$R = \frac{mv}{qB} \Rightarrow \frac{R_1}{R_2} = \frac{\frac{mv_1}{q_1 B}}{\frac{mv_2}{q_2 B}} = \frac{v_1}{q_1} \times \frac{q_2}{v_2} = \frac{q_2}{q_1} \times \frac{v_1}{v_2}$$

$$= \frac{2}{1} \times \left(\frac{2}{3}\right) = \frac{4}{3}$$

Question73

A deuteron and an alpha particle having equal kinetic energy enter perpendicular into a magnetic field. Let r_d and r_α be their respective radii of circular path. The value of $\frac{r_d}{r_\alpha}$ is equal to :

[20 Jul 2021 Shift 1]

Options:

- A. $\frac{1}{\sqrt{2}}$
- B. $\sqrt{2}$
- C. 1
- D. 2

Answer: B

Solution:

Solution:

$$r = \frac{mv}{qB} = \frac{\sqrt{2mk}}{qB}$$

$$\frac{r_d}{r_\alpha} = \sqrt{\frac{m_d q_\alpha}{m_\alpha q_d}} = \sqrt{\frac{2}{4} \left(\frac{2}{1}\right)} = \sqrt{2}$$

Hence option (2).

Question74

A coil having N turns is wound tightly in the form of a spiral with inner and outer radii a and b, respectively. Find the magnetic field at centre,

when a current / passes through coil [31 Aug 2021 Shift 1]

Options:

A. $\frac{\mu_0 IN}{2(b-a)} \ln\left(\frac{b}{a}\right)$

B. $\frac{\mu_0 I}{8} \ln\left[\frac{a+b}{a-b}\right]$

C. $\frac{\mu_0 I}{4(a-b)} \ln\left[\frac{1}{a} - \frac{1}{b}\right]$

D. $\frac{\mu_0 I}{8} \ln\left(\frac{a-b}{a+b}\right)$

Answer: A

Solution:

Solution:

Given, number of turns = N

Inner radius = a

Outer radius = b

Current = I

Consider an element of thickness dr at a distance r from the centre.

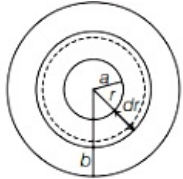

Now, number of turns in dr element, $dN = \frac{N}{(b-a)} dr$

Magnetic field due to this element at the centre,

$$dB = \frac{\mu_0 dN \cdot I}{2r}$$

$$\therefore dB = \frac{1}{2} \frac{\mu_0 I}{r} \frac{N}{(b-a)} dr$$

\therefore Total magnetic field at the centre,

$$B = \int_a^b dB = \int_a^b \frac{\mu_0 IN}{2(b-a)r} dr$$

$$= \frac{N}{2} \frac{\mu_0 I}{(b-a)} \ln r \Big|_a^b$$

$$= \frac{N}{2} \frac{\mu_0 I}{(b-a)} \ln\left(\frac{b}{a}\right)$$

Question75

A current of 1.5A is flowing through a triangle, of side 9 cm each. The magnetic field at the centroid of the triangle is (Assume that, the current is flowing in the clockwise direction.)
[31 Aug 2021 Shift 2]

Options:

A. $3 \times 10^{-7} T$, outside the plane of triangle



B. $2\sqrt{3} \times 10^{-7}\text{T}$, outside the plane of triangle

C. $2\sqrt{3} \times 10^{-5}\text{T}$, inside the plane of triangle

D. $3 \times 10^{-5}\text{T}$, inside the plane of triangle

Answer: D

Solution:

Solution:

Given, electric current, $I = 1.5\text{ A}$

Side of triangle, $l = 9\text{ cm} = 9 \times 10^{-2}\text{ m}$

Let $OD = OE = OF = r$

$$AD = \frac{l}{2}$$

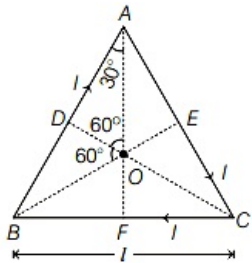

In $\triangle AOD$, $\frac{OD}{AD} = \tan 30^\circ$

$$OD = AD \tan 30^\circ$$

$$r = OD = \frac{l}{2} \times \frac{1}{\sqrt{3}} = \frac{l}{2\sqrt{3}}$$

Magnetic field due to AB at O,

$$B_1 = \frac{\mu_0 I}{4\pi r} [\sin 60^\circ + \sin 60^\circ] = \frac{\mu_0 I}{4\pi r} \times \frac{2\sqrt{3}}{2}$$

$$\Rightarrow B_1 = \frac{\mu_0 I \sqrt{3}}{4\pi r} \text{ (perpendicular inward)}$$

Now, total magnetic field at O due to all sides,

$$B = 3B_1 = \frac{\mu_0}{4\pi r} 3\sqrt{3}$$

By substituting the values, we get

$$B = \frac{10^{-7} \times 1.5 \times 3\sqrt{3} \times 2\sqrt{3}}{9 \times 10^{-2}} = 3 \times 10^{-5}\text{T (inside the plane of triangle)}$$

Question 76

A co-axial cable consists of an inner wire of radius a surrounded by an outer shell of inner and outer radii b and c , respectively. The inner wire carries an electric current i_0 , which is distributed uniformly across cross-sectional area. The outer shell carries an equal current in opposite direction and distributed uniformly. What will be the ratio of the magnetic field at a distance x from the axis when (i) $x < a$ and (ii) $a < x < b$?

[27 Aug 2021 Shift 2]

Options:

A. $\frac{x^2}{a^2}$

B. $\frac{a^2}{x^2}$

C. $\frac{x^2}{b^2 - a^2}$

D. $\frac{b^2 - a^2}{x^2}$

Answer: A

Solution:

radius of inner wire of co-axial cable = a
 radius of outer shell = b

Outer radius of outer shell = c

Let, magnetic field at distance $x < a = B_1$

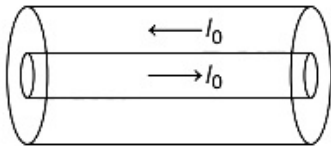

and magnetic field at distance

$a < x < b = B_2$

By using Ampere circuital law,

$$\oint \mathbf{B} \cdot d\mathbf{l} = n\mu_0 I_{enc}$$

where, $d\mathbf{l}$ = perimeter of small circular element,

n = number of turns,

μ_0 = free space permeability

and I = current.

$$\therefore B_1 \cdot 2\pi x = n\mu_0 I_{enc}$$

$$\Rightarrow B_1 = \frac{\mu_0}{2\pi x} \frac{I_0}{\pi a^2} \cdot \pi x^2$$

$$= \frac{\mu_0}{2\pi} \frac{I_0 x}{a^2}$$

Now, for $B_2(a < x < b)$

$$B_2 \cdot 2\pi x = \mu_0 I_0$$

$$B_2 = \frac{1}{2\pi} \frac{\mu_0 I_0}{x}$$

\therefore From Eqs. (i) and (ii) we will get

$$\frac{B_1}{B_2} = \frac{\frac{\mu_0 I_0 x}{2\pi a^2}}{\frac{\mu_0 I_0}{2\pi x}} = \frac{x^2}{a^2}$$

Question77

The fractional change in the magnetic field intensity at a distance r from centre on the axis of current carrying coil of radius a to the magnetic field intensity at the centre of the same coil is (Take, $r < a$) [26 Aug 2021 Shift 1]

Options:

A. $\frac{3a^2}{2r^2}$

B. $\frac{2a^2}{3r^2}$

C. $\frac{2r^2}{3a^2}$

D. $\frac{3r^2}{2a^2}$

Answer: D

Solution:

Solution:

The magnetic field intensity at a distance r from centre on the axis of a coil of radius a carrying current i is given by

$$B_{\text{axis}} = \frac{\mu_0}{4\pi} \frac{2\pi i a^2}{(a^2 + r^2)^{\frac{3}{2}}} \dots(i)$$

The magnetic field intensity at the centre of the coil is given by

$$B_{\text{centre}} = \frac{\mu_0}{4\pi} \frac{2\pi i}{a} \dots(ii)$$

According to question, the fractional change in the magnetic field intensity is given by

$$\frac{\Delta B}{B} = 1 - \frac{B_{\text{axis}}}{B_{\text{centre}}} \dots(iii)$$

Substituting the values of B_{axis} and B_{centre} from Eqs. (i) and (ii) respectively in Eq. (iii), we get

$$\frac{\Delta B}{B} = 1 - \frac{\frac{\mu_0}{4\pi} \frac{2\pi i a^2}{(a^2 + r^2)^{\frac{3}{2}}}}{\frac{\mu_0}{4\pi} \frac{2\pi i}{a}}$$

$$= 1 - \frac{a^3}{(a^2 + r^2)^{\frac{3}{2}}}$$

$$= 1 - \frac{a^3}{a^3 \left(1 + \frac{r^2}{a^2}\right)^{\frac{3}{2}}}$$

$$= 1 - \left(1 + \frac{r^2}{a^2}\right)^{-\frac{3}{2}}$$

Given that, $r < a$, applying Binomial expansion,

$$(1 - x)^{-n} = 1 - x + \frac{2x^2}{2!} - \frac{3 \times 2x^3}{3!} \dots (-1)^n x^n,$$

$$= (1 + nx)$$

$$\text{we get } \frac{\Delta B}{B} = 1 - \left(1 - \frac{3r^2}{2a^2}\right)$$

$$\frac{\Delta B}{B} = 1 - 1 + \frac{3r^2}{2a^2}$$

$$\frac{\Delta B}{B} = \frac{3r^2}{2a^2}, \text{ which is the required expression.}$$

Question 78

Two ions of masses 4 amu and 16 amu have charges +2e and +3e, respectively. These ions pass through the region of constant perpendicular magnetic field. The kinetic energy of both ions is same. Then,

[27 Aug 2021 Shift 1]

Options:

A. lighter ion will be deflected less than heavier ion

B. lighter ion will be deflected more than heavier ion

C. both ions will be deflected equally

D. no ion will be deflected

Answer: B

Solution:

Solution:

Given, mass of 1 st ion, $m_1 = 4 \text{ amu}$

Mass of 2 nd ion, $m_2 = 16 \text{ amu}$

Charge on 1 st ion, $q_1 = +2e$

Charge on 2 nd ion, $q_2 = +3e$

Kinetic energy of both ion is same,

$$KE_1 = KE_2$$

The radius of path traced by a charged particle in magnetic field is given as

$$r = \frac{\sqrt{2mKE}}{qB}$$

$$\Rightarrow r \propto \frac{\sqrt{m}}{q}$$

$$\Rightarrow \frac{r_1}{r_2} = \sqrt{\frac{m_1}{m_2}} \times \left(\frac{q_2}{q_1}\right)$$

$$\Rightarrow \frac{r_1}{r_2} = \sqrt{\frac{4}{16}} \times \left(\frac{+3e}{+2e}\right)$$

$$= \frac{1}{2} \times \frac{3}{2} = \frac{3}{4}$$

$$\Rightarrow r_1 = \frac{3}{4}r_2$$

$$\Rightarrow r_1 < r_2$$

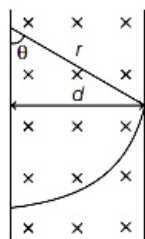

Now, the deflection of ion in region with constant magnetic field as shown in figure is denoted by θ .

From diagram,

$$\sin \theta = \frac{d}{r}$$

$$\theta \propto \frac{1}{r} [\because d = \text{constant}]$$

As, $r_1 < r_2$ from above expression $\theta_1 > \theta_2$.

Thus, deflection of lighter ion will be more than the deflection of heavier ion.

Question79

If the maximum value of accelerating potential provided by a radio frequency oscillator is 12 kV . The number of revolution made by a proton in a cyclotron to achieve one sixth of the speed of light is..... .

[Given, $m_p = 1.67 \times 10^{-27} \text{ kg}$, $e = 1.6 \times 10^{-19} \text{ C}$, $c = 3 \times 10^8 \text{ m / s}$]

[26 Aug 2021 Shift 2]

Answer: 543

Solution:

Given, maximum value of accelerating potential,
 $V = 12 \text{ kV} = 12000 \text{ V}$,

Speed achieved by a proton cyclotron, $v = \frac{c}{6}$

where, c is the speed of light $= 3 \times 10^8 \text{ ms}^{-1}$

Mass of proton, $m_p = 1.67 \times 10^{-27} \text{ kg}$

Charge of proton, $q_p = 1.6 \times 10^{-19} \text{ C}$

According to the question, assume a proton makes n revolutions in the cyclotron to achieve the speed v .

The energy absorbed by proton due to the accelerating potential provided by the radio oscillator

$$= n \times 2 \times q_p \times V$$

This energy absorbed by proton will be equal to the kinetic energy gain by the proton i.e.,

$$2nq_p V = \frac{m_p v^2}{2}$$

Substituting the given values in above expression, we get

$$n \times 2 \times 1.6 \times 10^{-19} \times 12000$$

$$= \frac{1}{2} \times 1.67 \times 10^{-27} \times \left(\frac{3 \times 10^8}{6} \right)^2$$

$$n \times 3.84 \times 10^{-15} = 2.0875 \times 10^{-12}$$

$$n = 543.62$$

As, n is number of revolutions, so it should be an integer.

$$\therefore n = 543$$

Question80

A coil in the shape of an equilateral triangle of side 10 cm lies in a vertical plane between the pole pieces of permanent magnet producing a horizontal magnetic field 20 mT. The torque acting on the coil when a current of 0.2A is passed through it and its plane becomes parallel to the magnetic field will be $\sqrt{x} \times 10^{-5} \text{ Nm}$. The value of x is..... .

[26 Aug 2021 Shift 2]

Answer: 3

Solution:

Side of equilateral triangular coil, $a = 10 \text{ cm} = 0.1 \text{ m}$

Horizontal magnetic field, $B = 20 \text{ mT} = 20 \times 10^{-3} \text{ T}$

Current in coil, $i = 0.2 \text{ A}$

Torque acting on coil, $\tau = \sqrt{x} \times 10^{-5} \text{ N - m}$

Torque acting on coil can be calculated as

$$= \vec{M} \times \vec{B} \sin \theta$$

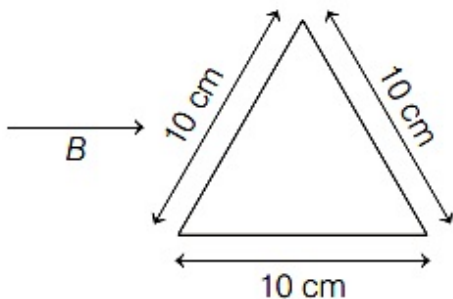

Here, M is pole strength and B is magnetic field. Magnetic pole strength, $M = iA$

$$\tau = i \left(\frac{\sqrt{3}}{4} a^2 \right) B \sin \theta \quad [\because A = \frac{\sqrt{3}}{4} a^2 \text{ (for equilateral triangle)}]$$

$$= 0.2 \times \frac{\sqrt{3}}{4} \times (0.1)^2 \times 20 \times 10^{-3} \times \sin 90^\circ \quad [\because A \perp B]$$

$$= \sqrt{3} \times 10^{-5} \text{ N-m}$$

After comparing obtained value with the given value, $x = 3$.

Question81

A uniform conducting wire of length is $24a$, and resistance R is wound up as a current carrying coil in the shape of an equilateral triangle of side a and then in the form of a square of side a . The coil is connected to a voltage source V_0 . The ratio of magnetic moment of the coils in case of equilateral triangle to that for square is $1 : \sqrt{y}$. The value of where y is

.....

[27 Aug 2021 Shift 1]

Solution:

Length of conducting wire, $l = 24a$

Resistance of wire is R .

Ratio of magnetic moment of coil for equilateral triangle to square is $1 : \sqrt{y}$.

Side of equilateral triangle is a and also side of square is a .

Number of turns in equilateral triangle will be

$$n_T = \frac{24a}{3a} = 8 \quad [\because \text{Length of one turn is } 3a]$$

Number of turns in square will be

$$n_S = \frac{24a}{4a} = 6 \quad [\because \text{Length of one turn is } 4a]$$

Magnetic moment of coil is given as

$$M = nIA$$

The ratio of magnetic moment for triangular coil to square coil is given as

$$\frac{M_T}{M_S} = \frac{n_T I A_T}{n_S I A_S} \quad (\because I \text{ is same in both coils})$$

Substituting the values in above expression, we get

$$\frac{1}{\sqrt{y}} = \frac{\left(8 \times \frac{\sqrt{3}}{4} a^2 \right)}{6 \times a^2} = \frac{8\sqrt{3}}{24} = \frac{1}{\sqrt{3}}$$

$$\Rightarrow \sqrt{y} = \sqrt{3}$$

$$\Rightarrow y = 3$$

Hence, the value of y is 3.

Question82

Two short magnetic dipoles m_1 and m_2 each having magnetic moment of 1 Am^2 are placed at point O and P, respectively. The distance between OP is 1 m. The torque experienced by the magnetic dipole m_2 due to the



presence of m_1 is $\times 10^{-7}$ Nm.

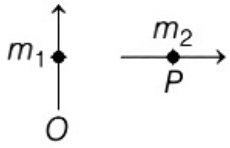

[26 Aug 2021 Shift 1]

Answer: 1

Solution:

Solution:

In the given figure,

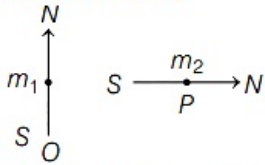

The direction of magnetic moment is from South to North.

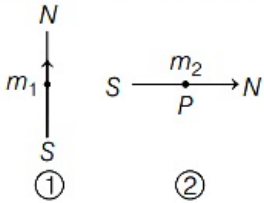

When second magnet is kept in the magnetic field produced by first magnet, the torque acting on second magnet is given by

$$\tau = M_2 \times B_1$$

$$|\tau| = M_2 B_1 \sin \theta \quad (\because \theta = 90^\circ)$$

$$|\tau| = M_2 B_1$$

Point P lie on equatorial position, so

$$B_1 = \frac{\mu_0 M_1}{4\pi r^3}$$

$$|\tau| = \left(\frac{\mu_0 M_1}{4\pi r^3} \right) M_2$$

$$M_1 = M_2 = 1 \text{ A-m}^2, r = 1 \text{ m (given)}$$

$$|\tau| = \frac{10^{-7} \times 1 \times 1}{(1)^3}$$

$$\Rightarrow |\tau| = 10^{-7} \text{ Nm}$$

$$\Rightarrow |\tau| = 1 \times 10^{-7} \text{ Nm}$$

Question83

Consider a galvanometer shunted with 5Ω resistance and 2% of current passes through it. What is the resistance of the given galvanometer ?

[31 Aug 2021 Shift 1]

Options:

A. 300Ω

B. 344Ω

C. 245Ω

D. 226Ω

Answer: C

Solution:

Solution:

Given,

Shunt resistance, $R_{sn} = 5\Omega$

Let galvanometer resistance = G

Total, current = I

Voltage across galvanometer (V_G) = Voltage across shunt resistance R_{sn}

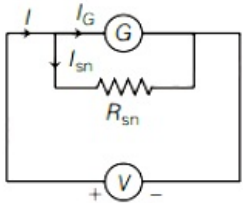

$$I_G \times G = I_{sn} \times R_{sn}$$

$$0.021 \times G = 0.981 \times 5$$

$$\Rightarrow G = \frac{98 \times 5}{2} = 49 \times 5 = 245\Omega$$

Question84

For full scale deflection of total 50 divisions, 50 mV voltage is required in galvanometer.

The resistance of galvanometer if its current sensitivity is 2 div / mA will be

[27 Aug 2021 Shift 2]

Options:

A. 1Ω

B. 5Ω

C. 4Ω

D. 2Ω

Answer: D

Solution:

Solution:

Given, number of divisions, $n = 50$

Voltage, $V = 50\text{mV} = 50 \times 10^{-3}\text{V}$

$$\text{Current sensitivity, } k = \frac{2\text{ div}}{\text{mA}} = \frac{2\text{ div}}{10^{-3}\text{A}}$$

$$\therefore \text{Current, } I = \frac{n}{k} = \frac{50 \times 10^{-3}}{2} = 25 \times 10^{-3}\text{A}$$

By using Ohm's law,

$$\text{Resistance (R)} = \frac{\text{Potential (V)}}{\text{Current (I)}}$$

$$= \frac{50 \times 10^{-3}}{25 \times 10^{-3}} = 2\Omega$$

Question85

There are two infinitely long straight current carrying conductors and they are held at right angles to each other so that their common ends meet at the origin as shown in the figure given below. The ratio of current in both conductors is 1 : 1. The magnetic field at point P is

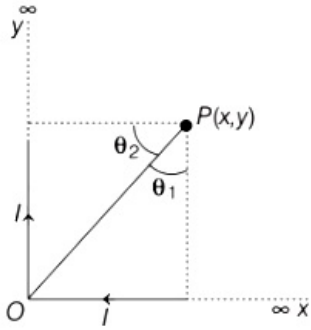

[1 Sep 2021 Shift 2]

Options:

- A. $\frac{\mu_0 I}{4\pi xy} [\sqrt{x^2 + y^2} + (x + y)]$
- B. $\frac{\mu_0 I}{4\pi xy} [\sqrt{x^2 + y^2} - (x + y)]$
- C. $\frac{\mu_0 Ixy}{4\pi} [\sqrt{x^2 + y^2} - (x + y)]$
- D. $\frac{\mu_0 Ixy}{4\pi} [\sqrt{x^2 + y^2} + (x + y)]$

Answer: A

Solution:

Solution:

The diagram is given below,

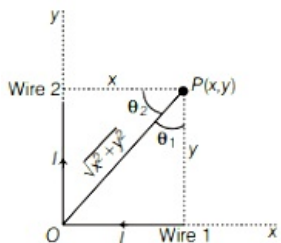

The magnetic field due to the wire 1,

$$B_{\text{wire1}} = \frac{\mu_0 I}{4\pi y} (\sin 90^\circ + \sin \theta_1)$$

$$\frac{\mu_0 I}{4\pi y} \left(1 + \frac{x}{\sqrt{x^2 + y^2}} \right)$$

The magnetic field due to the wire 2,

$$\frac{\mu_0 I}{4\pi x} (\sin 90^\circ + \sin \theta_2)$$

$$B_{\text{wire2}} = \frac{\mu_0 I}{4\pi x} \left(1 + \frac{y}{\sqrt{x^2 + y^2}} \right)$$

Thus, the total magnetic field,

$$B = B_1 + B_2$$

$$= \frac{\mu_0 I}{4\pi} \left(\frac{1}{y} + \frac{x}{y\sqrt{x^2 + y^2}} + \frac{1}{x} + \frac{y}{x\sqrt{x^2 + y^2}} \right)$$

$$= \frac{\mu_0 I}{4\pi xy} [\sqrt{x^2 + y^2} + (x + y)]$$

Question86

Proton with kinetic energy of 1MeV moves from south to north. It gets an acceleration of 10^{12} m/s^2 by an applied magnetic field (west to east). The value of magnetic field:

(Rest mass of proton is $1.6 \times 10^{-27} \text{ kg}$)

[8 Jan 2020, I]

Options:

A. 0.71mT

B. 7.1mT

C. 0.071mT

D. 71mT

Answer: A

Solution:

Solution:

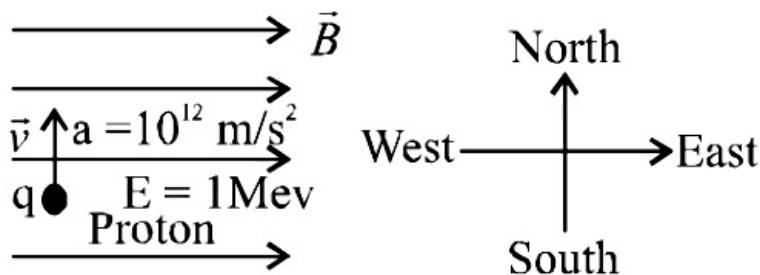

As we know, magnetic force $F = qvB = ma$

$$\therefore \vec{a} = \left(\frac{qvB}{m} \right) \text{ perpendicular to velocity.}$$

$$\therefore \text{Also } v = \sqrt{\frac{2KE}{m}} = \sqrt{\frac{2 \times e \times 10^6}{m}}$$

$$\therefore a = \frac{qvB}{m} = \frac{eB}{m} \sqrt{\frac{2 \times e \times 10^6}{m}}$$

$$\therefore 10^{12} = \left(\frac{1.6 \times 10^{-19}}{1.67 \times 10^{-27}} \right)^{\frac{3}{2}} \cdot \sqrt{2} \times 10^3 B$$

$$\therefore B \approx \frac{1}{\sqrt{2}} \times 10^{-3} \text{ T} = 0.71 \text{ mT (approx)}$$

Question87

A long, straight wire of radius a carries a current distributed uniformly

over its cross-section. The ratio of the magnetic fields due to the wire at distance $\frac{a}{3}$ and $2a$ respectively from the axis of the wire is:

[9 Jan 2020, I]

Options:

A. $\frac{2}{3}$

B. 2

C. $\frac{1}{2}$

D. $\frac{3}{2}$

Answer: A

Solution:

Solution:

Let a be the radius of the wire
Magnetic field at point A (inside)

$$B_A = \frac{\mu_0 i r}{2\pi a^2} = \frac{\mu_0 i \frac{a}{3}}{2\pi a^2} = \frac{\mu_0 i a}{\pi a^2 6} = \frac{\mu_0 i}{6\pi a}$$

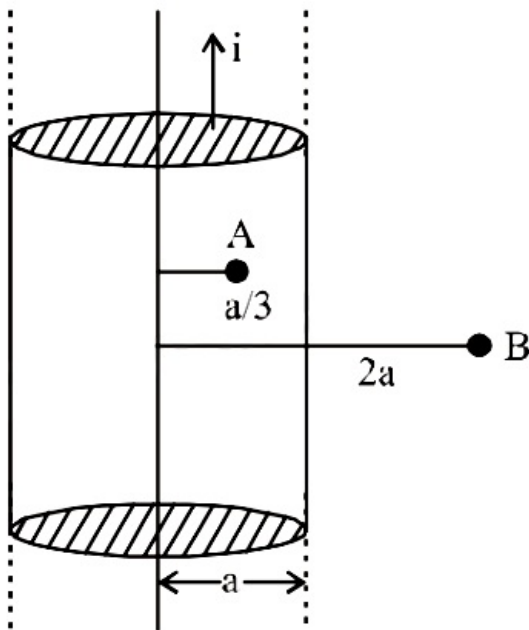

Magnetic field at point B (outside)

$$B_B = \frac{\mu_0 i}{2\pi(2a)}$$

$$\therefore \frac{B_A}{B_B} = \frac{\frac{\mu_0 i}{6\pi a}}{\frac{\mu_0 i}{2\pi(2a)}} = \frac{4}{6} = \frac{2}{3}$$

Question88

An electron gun is placed inside a long solenoid of radius R on its axis. The solenoid has n turns/length and carries a current I . The electron gun shoots an electron along the radius of the solenoid with speed v . If

the electron does not hit the surface of the solenoid, maximum possible value of v is (all symbols have their standard meaning):

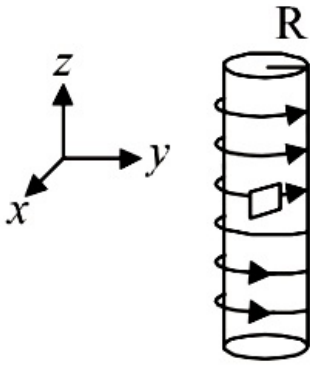

[9 Jan 2020, II]

Options:

A. $\frac{e\mu_0 n I R}{m}$

B. $\frac{e\mu_0 n I R}{2m}$

C. $\frac{e\mu_0 n I R}{4m}$

D. $\frac{2e\mu_0 n I R}{m}$

Answer: B

Solution:

Solution:

Magnetic field inside the solenoid is given by

$$B = \mu_0 n I \dots\dots(i)$$

Here, n = number of turns per unit length

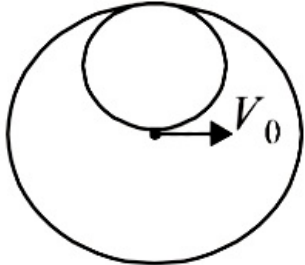

The path of charge particle is circular. The maximum possible radius of electron = $\frac{R}{2}$

$$\therefore \frac{mV_{\max}}{qB} = \frac{R}{2}$$

$$\Rightarrow V_{\max} = \frac{qBR}{2m} = \frac{eR\mu_0 n I}{2m} \text{ (using (i))}$$

Question89

A very long wire ABDMNDC is shown in figure carrying current I . AB and BC parts are straight, long and at right angle. At D wire forms a circular turn DMND of radius R .

AB, BC parts are tangential to circular turn at N and D. Magnetic field

at the centre of circle is:

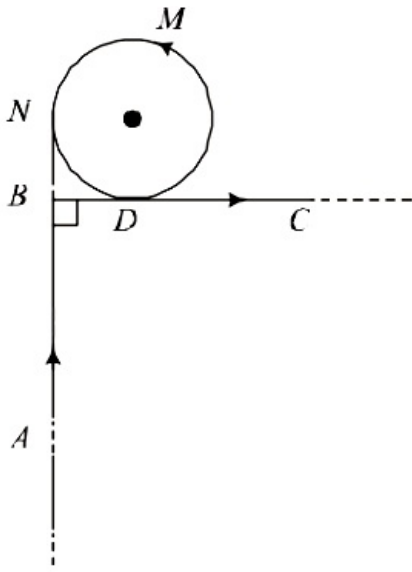

[8 Jan 2020, II]

Options:

A. $\frac{\mu_0 I}{2\pi R} \left(\pi + \frac{1}{\sqrt{2}} \right)$

B. $\frac{\mu_0 I}{2\pi R} \left(\pi - \frac{1}{\sqrt{2}} \right)$

C. $\frac{\mu_0 I}{2\pi R} (\pi + 1)$

D. $\frac{\mu_0 I}{2R}$

Answer: A

Solution:

Solution:

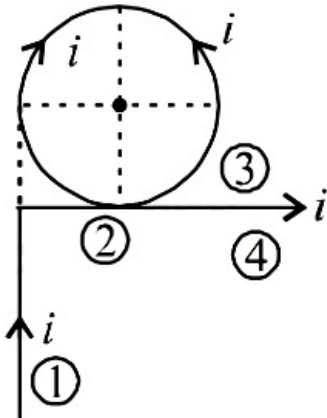

$$\begin{aligned}
 B_0 &= B_1 + B_2 + B_3 + B_4 \\
 &= \frac{\mu_0 I}{4\pi R} [\sin 90^\circ - \sin 45^\circ] + \frac{\mu_0 I}{2R} + \frac{\mu_0 I}{4\pi R} \\
 &\quad [\sin 45^\circ + \sin 90^\circ] \\
 &= -\frac{\mu_0 I}{4\pi R} \left(1 - \frac{1}{\sqrt{2}} \right) + \frac{\mu_0 I}{2R} + \frac{\mu_0 I}{4\pi R} \left(1 + \frac{1}{\sqrt{2}} \right) \\
 \vec{B}_0 &= \frac{\mu_0 I}{2\pi R} \left(\pi + \frac{1}{\sqrt{2}} \right) \hat{i}
 \end{aligned}$$

Question90

A small circular loop of conducting wire has radius a and carries current I . It is placed in a uniform magnetic field B perpendicular to its plane such that when rotated slightly about its diameter and released, it starts performing simple harmonic motion of time period T . If the mass of the loop is m then :

[9 Jan 2020, II]

Options:

A. $T = \sqrt{\frac{2m}{IB}}$

B. $T = \sqrt{\frac{\pi m}{2IB}}$

C. $T = \sqrt{\frac{2\pi m}{IB}}$

D. $T = \sqrt{\frac{\pi m}{IB}}$

Answer: C

Solution:

Solution:

Torque on circular loop, $\tau = MB \sin \theta$

where, $M =$ magnetic moment

$B =$ magnetic field

Now, using $\tau = I \alpha$

$\therefore \tau = MB \sin \theta = I \alpha$

$$\Rightarrow \pi R^2 I B \theta = \frac{m R^2 \alpha}{2}$$

($\because m = IA$ and moment of inertia of circular loop, $I = \frac{m R^2}{2}$)

$$\Rightarrow \pi R^2 I B \theta = \frac{m R^2}{2} \omega \theta$$

$$\Rightarrow \omega = \sqrt{\frac{2\pi I B}{m}} \Rightarrow \frac{2\pi}{T} = \sqrt{\frac{2\pi I B}{m}}$$

$$\Rightarrow T = \sqrt{\frac{2\pi m}{IB}}$$

Question91

An electron is moving along $+x$ direction with a velocity of $6 \times 10^6 \text{ ms}^{-1}$. It enters a region of uniform electric field of 300 V/cm pointing along $+y$ direction. The magnitude and direction of the magnetic field set up in this region such that the electron keeps moving along the x direction will be:

[Sep. 06, 2020 (I)]

Options:



- A. $3 \times 10^{-4} \text{T}$, along +z direction
- B. $5 \times 10^{-3} \text{T}$, along -z direction
- C. $5 \times 10^{-3} \text{T}$, along +z direction
- D. $3 \times 10^{-4} \text{T}$, along -z direction

Answer: C

Solution:

Solution:

$$\vec{E} = 300 \hat{j} \text{ V/cm} = 3 \times 10^4 \text{ V/m}$$

$$\vec{V} = 6 \times 10^6 \hat{i}$$

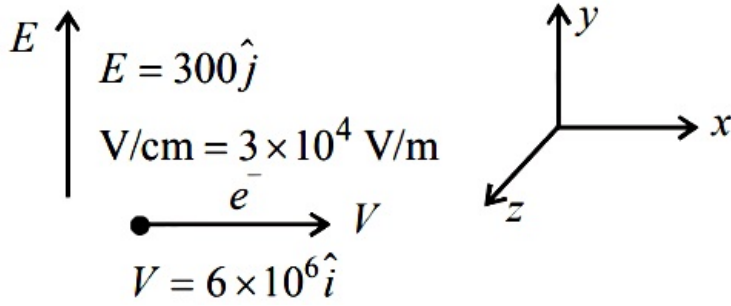

\vec{B} must be in +z axis.

$$q\vec{E} + q\vec{V} \times \vec{B} = 0$$

$$\vec{E} = \vec{V} \times \vec{B}$$

$$\therefore B = \frac{E}{V} = \frac{3 \times 10^4}{6 \times 10^6} = 5 \times 10^{-3} \text{T}$$

Question92

A particle of charge q and mass m is moving with a velocity $-v\hat{i}$ ($v \neq 0$) towards a large screen placed in the Y-Z plane at a distance d . If there is a magnetic field $\vec{B} = B_0\hat{k}$, the minimum value of v for which the particle will not hit the screen is:

[Sep. 06, 2020 (I)]

Options:

- A. $\frac{qd B_0}{3m}$
- B. $\frac{2qd B_0}{m}$
- C. $\frac{qd B_0}{m}$
- D. $\frac{qd B_0}{2m}$

Answer: C

Solution:

In uniform magnetic field particle moves in a circular path, if the radius of the circular path is 'r', particle will not hit the screen.

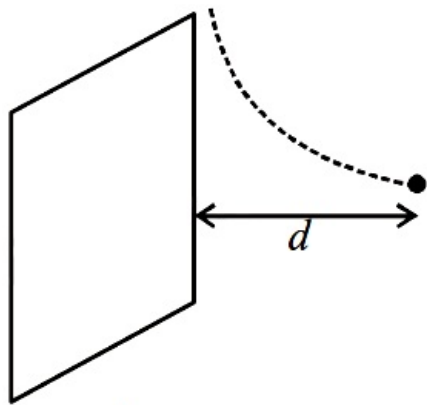

$$r = \frac{mv}{qB_0} \left[\because \frac{mv^2}{r} = qvB_0 \right]$$

Hence, minimum value of v for which the particle will not hit the screen.

$$v = \frac{qB_0 d}{m}$$

Question93

A charged particle carrying charge $1\mu\text{C}$ is moving with velocity $(2\hat{i} + 3\hat{j} + 4\hat{k})\text{ms}^{-1}$. If an external magnetic field of $(5\hat{i} + 3\hat{j} - 6\hat{k}) \times 10^{-3}\text{T}$ exists in the region where the particle is moving then the force on the particle is $\vec{F} \times 10^{-9}\text{N}$. The vector \vec{F} is:
[Sep. 03, 2020 (I)]

Options:

A. $-0.30\hat{i} + 0.32\hat{j} - 0.09\hat{k}$

B. $-30\hat{i} + 32\hat{j} - 9\hat{k}$

C. $-300\hat{i} + 320\hat{j} - 90\hat{k}$

D. $-3.0\hat{i} + 3.2\hat{j} - 0.9\hat{k}$

Answer: A

Solution:

[Given: $q = 1\mu\text{C} = 1 \times 10^{-6}\text{C}$

$\vec{v} = (2\hat{i} + 3\hat{j} + 4\hat{k})\text{m/s}$ and

$\vec{B} = (5\hat{i} + 3\hat{j} - 6\hat{k}) \times 10^{-3}\text{T}$]

$$\vec{F} = q(\vec{v} \times \vec{B}) = 10^{-6} \times 10^{-3} \begin{vmatrix} \hat{i} & \hat{j} & \hat{k} \\ 2 & 3 & 4 \\ 5 & 3 & -6 \end{vmatrix}$$

$$= (-30\hat{i} + 32\hat{j} - 9\hat{k}) \times 10^{-9}\text{N}$$

$$\therefore \vec{F} = (-30\hat{i} + 32\hat{j} - 9\hat{k})$$

Question94

A beam of protons with speed $4 \times 10^5 \text{ms}^{-1}$ enters a uniform magnetic field of 0.3T at an angle of 60° to the magnetic field. The pitch of the resulting helical path of protons is close to : (Mass of the proton = $1.67 \times 10^{-27}\text{kg}$, charge of the proton = $1.69 \times 10^{-19}\text{C}$)
[Sep. 02, 2020 (I)]

Options:

- A. 2cm
- B. 5cm
- C. 12cm
- D. 4cm

Answer: D

Solution:

Solution:

$$\text{Pitch} = (v \cos \theta)T \text{ and } T = \frac{2\pi m}{qB}$$

$$\therefore \text{Pitch} = (V \cos \theta) \frac{2\pi m}{qB}$$

$$= (4 \times 10^5 \cos 60^\circ) \frac{2\pi}{0.3} \left(\frac{1.67 \times 10^{-27}}{1.69 \times 10^{-19}} \right) = 4\text{cm}$$

Question95

The figure shows a region of length 'l' with a uniform magnetic field of 0.3T in it and a proton entering the region with velocity $4 \times 10^5 \text{ms}^{-1}$ making an angle 60° with the field. If the proton completes 10 revolution by the time it cross the region shown, 'l' is close to (mass of proton = $1.67 \times 10^{-27}\text{kg}$, charge of the proton = $1.6 \times 10^{-19}\text{C}$)

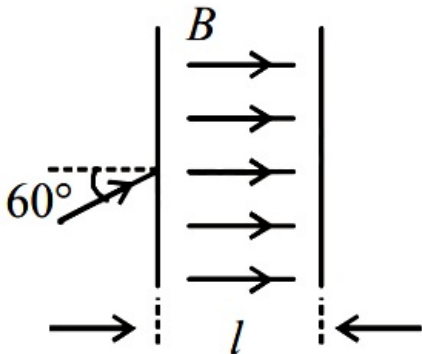

[Sep. 02, 2020 (II)]

Options:

- A. 0.11m

B. 0.88m

C. 0.44m

D. 0.22m

Answer: C

Solution:

Solution:

Time period of one revolution of proton, $T = \frac{2\pi m}{qB}$

Here, m = mass of proton

q = charge of proton

B = magnetic field.

Linear distance travelled in one revolution,

$p = T(v \cos \theta)$ (Here, v = velocity of proton)

\therefore Length of region, $l = 10 \times (v \cos \theta)T$

$$\Rightarrow l = 10 \times v \cos 60^\circ \times \frac{2\pi m}{qB}$$

$$\Rightarrow l = \frac{20\pi m v}{qB} = \frac{20 \times 3.14 \times 1.67 \times 10^{-27} \times 4 \times 10^5}{1.6 \times 10^{-19} \times 0.3}$$

$$\Rightarrow l = 0.44\text{m}$$

Question96

A charged particle going around in a circle can be considered to be a current loop. A particle of mass m carrying charge q is moving in a plane with speed v under the influence of magnetic field \vec{B} . The magnetic moment of this moving particle :

[Sep. 06, 2020 (II)]

Options:

A. $\frac{mv^2\vec{B}}{2B^2}$

B. $-\frac{mv^2\vec{B}}{2\pi B^2}$

C. $-\frac{mv^2\vec{B}}{B^2}$

D. $-\frac{mv^2\vec{B}}{2B^2}$

Answer: D

Solution:

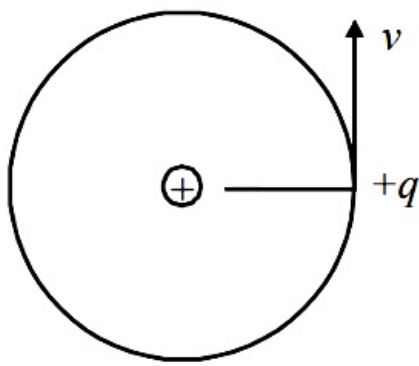

Length of the circular path, $l = 2\pi r$

$$\text{Current, } i = \frac{q}{T} = \frac{qv}{2\pi r}$$

Magnetic moment $M = \text{Current} \times \text{Area}$

$$= i \times \pi r^2 = \frac{qv}{2\pi r} \times \pi r^2$$

$$M = \frac{1}{2} q \cdot v \cdot r$$

Radius of circular path in magnetic field, $r = \frac{mv}{qB}$

$$\therefore M = \frac{1}{2} qv \times \frac{mv}{qB} \Rightarrow M = \frac{mv^2}{2B}$$

Direction of \vec{M} is opposite of \vec{B} therefore

$$\vec{M} = \frac{-mv^2 \vec{B}}{2B^2}$$

(By multiplying both numerator and denominator by B).

Question 97

A wire A, bent in the shape of an arc of a circle, carrying a current of 2 A and having radius 2 cm and another wire B, also bent in the shape of arc of a circle, carrying a current of 3 A and having radius of 4 cm, are placed as shown in the figure. The ratio of the magnetic fields due to the wires A and B at the common centre O is :

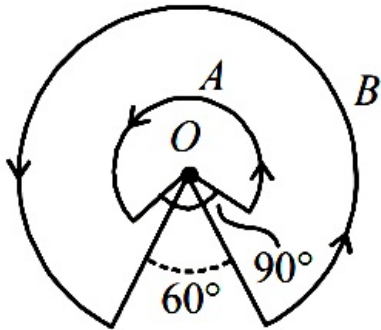

[Sep. 04, 2020 (I)]

Options:

- A. 4 : 6
- B. 6 : 4
- C. 2 : 5
- D. 6 : 5

Answer: D

Solution:

Given: $I_A = 2A$, $R_A = 2\text{cm}$, $\theta_A = 2\pi - \frac{\pi}{2} = \frac{3\pi}{2}$

$I_B = 3A$, $R_B = 4\text{cm}$, $\theta_B = 2\pi - \frac{\pi}{3} = \frac{5\pi}{3}$

Using, magnetic field, $B = \frac{\mu_0 I \theta}{4\pi R}$

$$\frac{B_A}{B_B} = \frac{I_A}{I_B} \times \frac{\theta_A R_B}{\theta_B R_A} = \frac{2 \times \frac{3\pi}{2} \times 4}{3 \times \frac{5\pi}{3} \times 2} = \frac{6}{5}$$

Question98

Magnitude of magnetic field (in SI units) at the centre of a hexagonal shape coil of side 10cm, 50 turns and carrying current I (Ampere) in units of $\frac{\mu_0 I}{\pi}$ is :

[Sep. 03,2020 (I)]

Options:

A. $250\sqrt{3}$

B. $50\sqrt{3}$

C. $500\sqrt{3}$

D. $5\sqrt{3}$

Answer: C

Solution:

Solution:

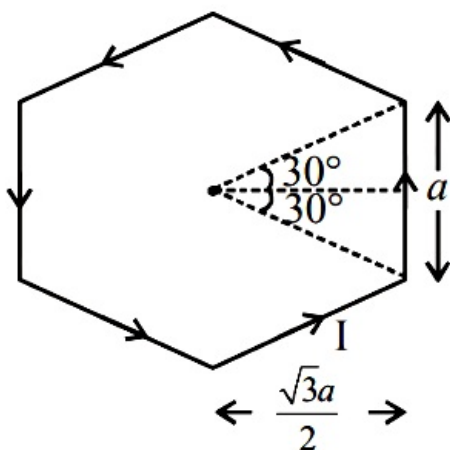

Magnetic field due to one side of hexagon $B = \frac{\mu_0 I}{4\pi \frac{\sqrt{3}a}{2}} (\sin 30^\circ + \sin 30^\circ)$

$$\Rightarrow B = \frac{\mu_0 I}{2\sqrt{3}a} \left(\frac{1}{2} + \frac{1}{2} \right) = \frac{\mu_0 I}{2\sqrt{3}a\pi}$$

Now, magnetic field due to one hexagon coil

$$B = 6 \times \frac{\mu_0 I}{2\sqrt{3}a\pi}$$

Again magnetic field at the centre of hexagonal shape coil of 50 turns,

$$B = 50 \times 6 \times \frac{\mu_0 I}{2\sqrt{3}a\pi} \left[\because a = \frac{10}{100} = 0.1\text{m} \right]$$

$$\text{or, } B = \frac{150\mu_0 I}{\sqrt{3} \times 0.1 \times \pi} = 500\sqrt{3} \frac{\mu_0 I}{\pi}$$

Question99

A square loop of side $2a$ and carrying current I is kept in xz plane with its centre at origin. A long wire carrying the same current I is placed parallel to z -axis and passing through point $(0, b, 0)$, ($b \gg a$). The magnitude of torque on the loop about z -axis will be :
[Sep. 06, 2020 (II)]

Options:

- A. $\frac{2\mu_0 I^2 a^2}{\pi b}$
 B. $\frac{2\mu_0 I^2 a^2 b}{\pi(a^2 + b^2)}$
 C. $\frac{\mu_0 I^2 a^2 b}{2\pi(a^2 + b^2)}$
 D. $\frac{\mu_0 I^2 a^2}{2\pi b}$

Answer: B

Solution:

Solution:

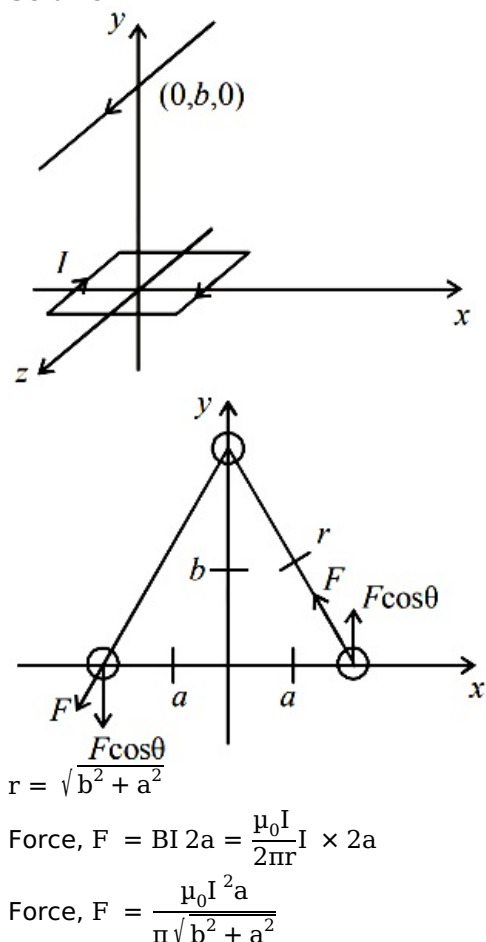

Torque, $\tau = F_1 \times \text{Perpendicular distance} = F \cos \theta \times 2a$

$$= \frac{\mu_0 I^2 a}{\pi \sqrt{b^2 + a^2}} \times \frac{b}{\sqrt{b^2 + a^2}} \times 2a$$

$$\Rightarrow \tau = \frac{2\mu_0 I^2 a^2 b}{\pi(a^2 + b^2)}$$

If $b \gg a$ then $\tau = \frac{2\mu_0 I^2 a^2}{\pi b}$

Question100

A square loop of side $2a$, and carrying current I , is kept in XZ plane with its centre at origin. A long wire carrying the same current I is placed parallel to the z -axis and passing through the point $(0, b, 0)$, ($b \gg a$). The magnitude of the torque on the loop about z -axis is given by :

[Sep. 05,2020 (I)]

Options:

A. $\frac{\mu_0 I^2 a^2}{2\pi b}$

B. $\frac{\mu_0 I^2 a^3}{2\pi b^2}$

C. $\frac{2\mu_0 I^2 a^2}{\pi b}$

D. $\frac{2\mu_0 I^2 a^3}{\pi b^2}$

Answer: C

Solution:

Solution:

Torque on the loop,

$$\vec{\tau} = \vec{M} \times \vec{B} = MB \sin \theta = MB \sin 90^\circ$$

Magnetic field, $B = \frac{\mu_0 I}{2\pi d}$

$$\therefore \tau = I_1 (2a)^2 \left(\frac{\mu_0 I_2}{2\pi d} \right) \sin 90^\circ$$

$$= \frac{2\mu_0 I_1 I_2}{\pi d} \times a^2 = \frac{2\mu_0 I^2 a^2}{\pi d}$$

Question101

A wire carrying current I is bent in the shape ABCDEFA as shown, where rectangle ABCDA and ADEFA are perpendicular to each other. If the sides of the rectangles are of lengths a and b , then the magnitude and direction of magnetic moment of the loop ABCDEFA is :

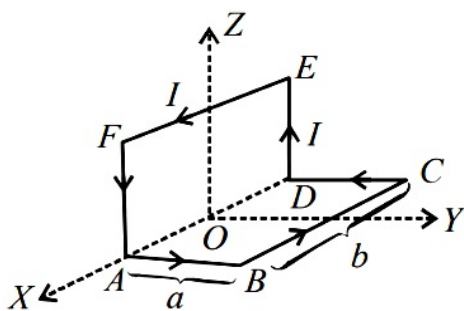

[Sep. 02, 2020 (II)]

Options:

- A. abI , along $\left(\frac{\hat{j}}{\sqrt{2}} + \frac{\hat{k}}{\sqrt{2}} \right)$
- B. $\sqrt{2}abI$, along $\left(\frac{\hat{j}}{\sqrt{2}} + \frac{\hat{k}}{\sqrt{2}} \right)$
- C. $\sqrt{2}abI$, along $\left(\frac{\hat{j}}{\sqrt{5}} + \frac{2\hat{k}}{\sqrt{5}} \right)$
- D. abI , along $\left(\frac{\hat{j}}{\sqrt{5}} + \frac{2\hat{k}}{\sqrt{5}} \right)$

Answer: B

Solution:

Solution:

Magnetic moment of loop ABCD,

$M_1 = \text{area of loop} \times \text{current}$

$\vec{M}_1 = (abI)(\hat{j})$ (Here ,ab = area of rectangle)

Magnetic moment of loop DE F A,

$\vec{M}_2 = (abI)(\hat{i})$

Net magnetic moment,

$\vec{M} = \vec{M}_1 + \vec{M}_2 \Rightarrow \vec{M} = abI(\hat{i} + \hat{j})$

$\Rightarrow |\vec{M}| = \sqrt{2}abI \left(\frac{\hat{j}}{\sqrt{2}} + \frac{\hat{k}}{\sqrt{2}} \right)$

Question102

- A. G
- B. R_1
- C. $R_1 - G$
- D. $R_1 + G$

Answer: D

Solution:

Solution:

Galvanometer of resistance (G) converted into a voltmeter of range 0 – 1V



$$V = 1 = i_g(G + R_1) \dots\dots(i)$$

To increase the range of voltmeter 0 – 2V

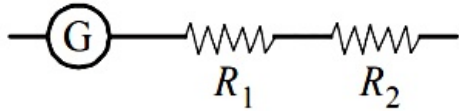

$$2 = i_g(R_1 + R_2 + G) \dots\dots(ii)$$

Dividing eq. (i) by (ii),

$$\Rightarrow \frac{1}{2} = \frac{G + R_1}{G + R_1 + R_2}$$

$$\Rightarrow G + R_1 + R_2 = 2G + 2R_1$$

$$\therefore R_2 = G + R_1$$

Question103

A galvanometer is used in laboratory for detecting the null point in electrical experiments. If, on passing a current of 6mA it produces a deflection of 2°, its figure of merit is close to :

[Sep. 05, 2020 (II)]

Options:

- A. 333°A / div.
- B. 6×10^{-3} A / div
- C. 666°A / div.
- D. 3×10^{-3} A / div

Answer: D

Solution:

Solution:

Given,
Current passing through galvanometer, I = 6mA
Deflection, $\theta = 2^\circ$

Figure of merit of galvanometer

$$= \frac{I}{\theta} = \frac{6 \times 10^{-3}}{2} = 3 \times 10^{-3} \text{ A / div}$$

Question104

A galvanometer coil has 500 turns and each turn has an average area of $3 \times 10^{-4} \text{ m}^2$. If a torque of 1.5N m is required to keep this coil parallel to a magnetic field when a current of 0.5A is flowing through it, the strength of the field (in T) is _____ .

[NA Sep. 03, 2020 (II)]

Answer: 20

Solution:

Solution:

Given.

Area of galvanometer coil, $A = 3 \times 10^{-4} \text{ m}^2$

Number of turns in the coil, $N = 500$

Current in the coil, $I = 0.5 \text{ A}$

Torque $\tau = |\vec{M} \times \vec{B}| = N i A B \sin(90^\circ) = N i A B$

$$\Rightarrow B = \frac{\tau}{N i A} = \frac{1.5}{500 \times 0.5 \times 3 \times 10^{-4}} = 20 \text{ T}$$

Question105

A proton and an α -particle (with their masses in the ratio of 1: 4 and charges in the ratio 1: 2) are accelerated from rest through a potential difference V . If a uniform magnetic field (B) is set up perpendicular to their velocities, the ratio of the radii $r_p : r_\alpha$ of the circular paths

described by them will be:

[12 Jan 2019, I]

Options:

A. $1 : \sqrt{2}$

B. $1 : 2$

C. $1 : 3$

D. $1 : \sqrt{3}$

Answer: A

Solution:



Radius of the circular path will be $r = \frac{mv}{qB}$

$$\Rightarrow r = \frac{\sqrt{2mKE}}{qB} \quad (\because p = mv = \sqrt{2mKE})$$

$$\because KE = q\Delta V$$

$$\therefore r = \frac{\sqrt{2mq\Delta V}}{qB} \Rightarrow r \propto \sqrt{\frac{m}{q}}$$

$$\therefore \frac{r_p}{r_\alpha} = \frac{1}{\sqrt{2}}$$

Question 106

In an experiment, electrons are accelerated, from rest, by applying a voltage of 500V. Calculate the radius of the path if a magnetic field 100mT is then applied.

[Charge of the electron = $1.6 \times 10^{-19}C$

Mass of the electron = $9.1 \times 10^{-31}kg$]

[11 Jan 2019, I]

Options:

A. $7.5 \times 10^{-3}m$

B. $7.5 \times 10^{-2}m$

C. 7.5m

D. $7.5 \times 10^{-4}m$

Answer: D

Solution:

Solution:

Radius of the path (r) is given by $r = \frac{mv}{qB}$

$$r = \frac{\sqrt{2mk}}{eB} \quad (\because p = mv = \sqrt{2mk})$$

$$= \frac{\sqrt{2mV}}{eB} \quad (\because k = eV)$$

$$r = \frac{\sqrt{\frac{2mV}{e}}}{B} = \frac{\sqrt{\frac{2 \times 9.1 \times 10^{-31}}{1.6 \times 10^{-19}}(500)}}{100 \times 10^{-3}}$$

$$r = \frac{\sqrt{\frac{9.1}{0.16} \times 10^{-10}}}{10^{-1}} = \frac{3}{4} \times 10^{-4}$$

$$= 7.5 \times 10^{-4}m$$

Question 107

The region between $y = 0$ and $y = d$ contains a magnetic field $\vec{B} = B\hat{z}$. A particle of mass m and charge q enters the region with a velocity $\vec{v} = v\hat{i}$.

if $d = \frac{mv}{2qB}$, the acceleration of the charged particle at the point of its emergence at the other side is :

[11 Jan 2019, II]

Options:

A. $\frac{qvB}{m} \left(\frac{1}{2} \hat{i} - \frac{\sqrt{3}}{2} \hat{j} \right)$

B. $\frac{qvB}{m} \left(\frac{\sqrt{3}}{2} \hat{i} + \frac{1}{2} \hat{j} \right)$

C. $\frac{qvB}{m} \left(\frac{-\hat{j} + \hat{i}}{\sqrt{2}} \right)$

D. (BONUS)

Answer: D

Solution:

Solution:

Assuming particle enters from $(0, d)$

$$r = \frac{mv}{qB}, d = \frac{r}{2}$$

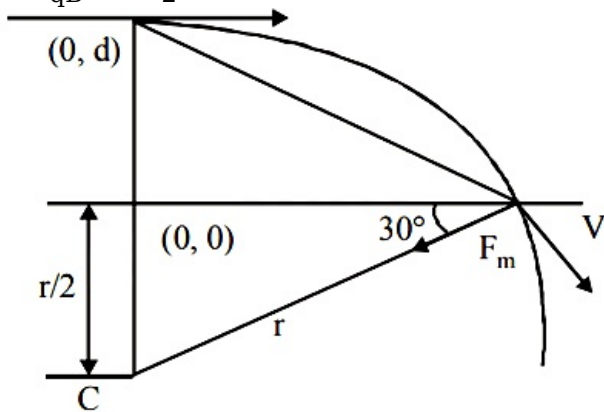

$$a = \frac{qVB}{m} \left[\frac{-\sqrt{3}\hat{i} - \hat{j}}{2} \right]$$

this option is not given in the all above four choices

Question108

As shown in the figure, two infinitely long, identical wires are bent by 90° and placed in such a way that the segments LP and QM are along the x-axis, while segments PS and QN are parallel to the y-axis. If $OP = OQ = 4\text{cm}$, and the magnitude of the magnetic field at O is 10^{-4}T , and the two wires carry equal currents (see figure), the magnitude of the current in each wire and the direction of the magnetic field at O will be ($\mu_0 = 4\pi \times 10^{-7}\text{N A}^{-2}$):

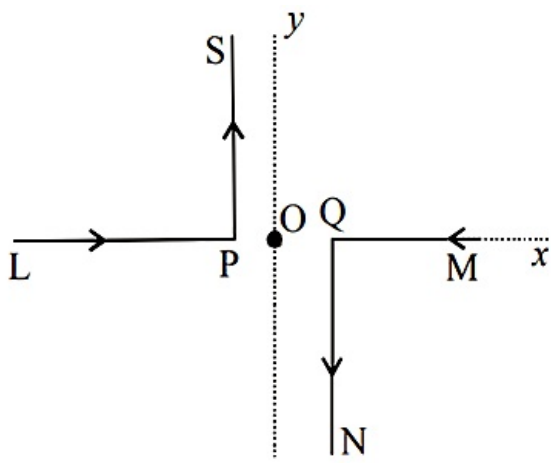

""[12 Jan 2019, I]

Options:

- A. 20 A, perpendicular out of the page
- B. 40 A, perpendicular out of the page
- C. 20 A, perpendicular into the page
- D. 40 A, perpendicular into the page

Answer: C

Solution:

Solution:

Let I be the current in each wire. (directed inwards)
 Magnetic field at 'O' due to LP and QM will be zero.
 i.e., $B_0 = B_{PS} + B_{QN}$

$$\therefore \text{Net magnetic field } B_0 = \frac{\mu_0 i}{4\pi d} + \frac{\mu_0 i}{4\pi d}$$

$$\text{or } 10^{-4} = \frac{\mu_0 i}{2\pi d} + \frac{2 \times 10^{-7} \times i}{4 \times 10^{-2}}$$

$\therefore i = 20\text{A}$ and the direction of magnetic field is perpendicular into the plane

Question109

A current loop, having two circular arcs joined by two radial lines is shown in the figure. It carries a current of 10 A. The magnetic field at point O will be close to:

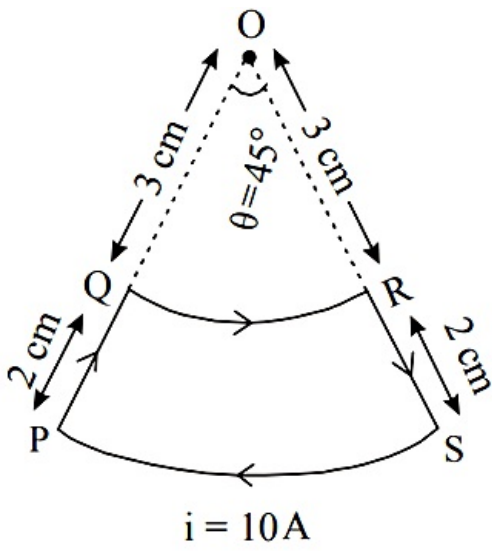

[9 Jan. 2019 I]

Options:

- A. $1.0 \times 10^{-7}\text{ T}$
- B. $1.5 \times 10^{-7}\text{ T}$
- C. $1.5 \times 10^{-5}\text{ T}$
- D. $1.0 \times 10^{-5}\text{ T}$

Answer: D

Solution:

Solution:

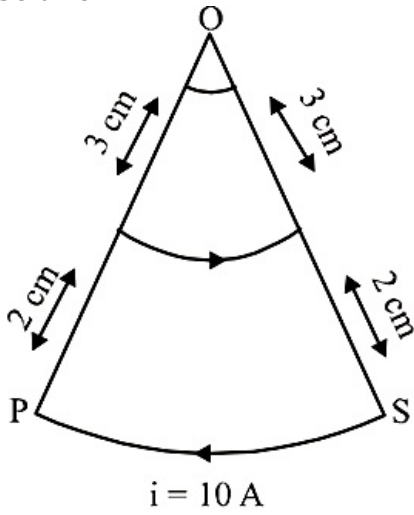

There will be no magnetic field at O due to wire PQ and RS
Magnetic field at 'O' due to arc QR

$$= \frac{\mu_0}{4\pi} \frac{\left(\frac{\pi}{4}\right) \cdot I}{r_1}$$

Magnetic field at 'O' due to arc PS

$$= \frac{\mu_0}{4\pi} \frac{\left(\frac{\pi}{4}\right) \cdot I}{r_2}$$

\therefore Net magnetic field at 'O'

$$B = \frac{\mu_0}{4\pi} (\pi/4) \times 10 \left[\frac{1}{(3 \times 10^{-2})} - \frac{1}{(5 \times 10^{-2})} \right]$$

$$\Rightarrow |\vec{B}| = \frac{\pi}{3} \times 10^{-5}\text{ T} \approx 1 \times 10^{-5}\text{ T}$$

Question110

One of the two identical conducting wires of length L is bent in the form of a circular loop and the other one into a circular coil of N identical turns. If the same current is passed in both, the ratio of the magnetic field at the central of the loop (B_L) to that at the centre of the coil (B_C),

i.e., $\frac{B_L}{B_C}$ will be:

[9 Jan 2019, II]

Options:

- A. N
- B. $\frac{1}{N}$
- C. N^2
- D. $\frac{1}{N^2}$

Answer: D

Solution:

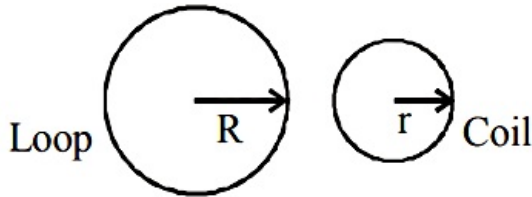

$$L = 2\pi R \quad L = N \times 2\pi r$$

$$R = N r \Rightarrow r = \frac{R}{N}$$

$$B_{\text{Loop}} = \frac{\mu_0 i}{2R} \quad B_{\text{coil}} = \frac{\mu_0 N i}{2r} = \frac{\mu_0 N i}{2\left(\frac{R}{N}\right)} = \frac{\mu_0 N^2 i}{2R}$$

$$\therefore \frac{B_L}{B_C} = \frac{1}{N^2}$$

Question111

An infinitely long current carrying wire and a small current carrying loop are in the plane of the paper as shown. The radius of the loop is a and distance of its centre from the wire is d ($d \gg a$). If the loop applies a force F on the wire then:

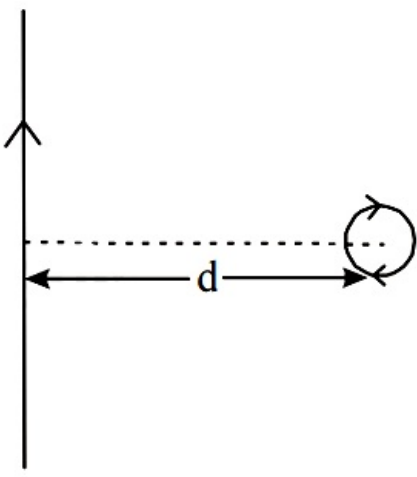

[9 Jan. 2019 I]

Options:

A. $F = 0$

B. $F \propto \left(\frac{a}{d}\right)$

C. $F \propto \left(\frac{a^2}{d^3}\right)$

D. $F \propto \left(\frac{a}{d}\right)^2$

Answer: D

Solution:

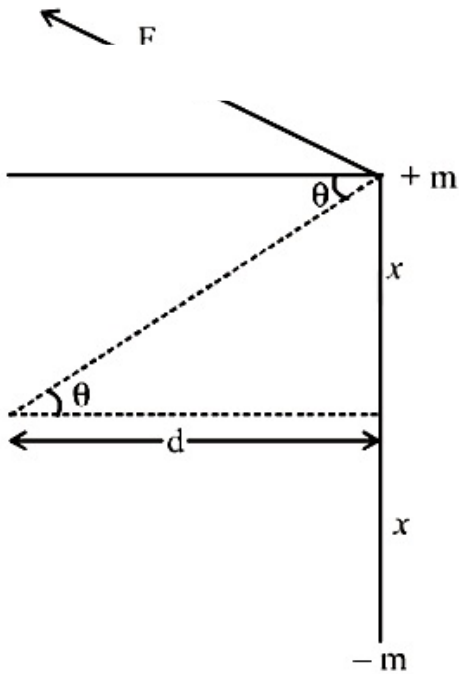

Force on one pole,

$$F = m \times \frac{\mu_0 I}{2\pi \sqrt{d^2 + x^2}}$$

Total force, $F_{\text{total}} = 2F \sin \theta$

$$= 2 \times \frac{\mu_0 I m}{2\pi \sqrt{d^2 + a^2}} \times \frac{x}{\sqrt{d^2 + a^2}}$$

$$= \frac{\mu_0 I m x}{\pi(d^2 + a^2)}$$

Magnetic moment, $M = I \pi a^2 = m \times 2$

$$\text{or, Total force, } F_{\text{total}} = \frac{\mu_0 I a^2}{2(d^2 + a^2)}$$

$$= \frac{\mu_0 I a^2}{2d^2} [\because d \gg a]$$

$$\text{Clearly } F_{\text{total}} \propto \frac{a^2}{d^2}$$

Question 112

The galvanometer deflection, when key K_1 is closed but K_2 is open, equals θ_0 (see figure). On closing K_2 also and adjusting R_2 to 5Ω , the deflection in galvanometer becomes $\frac{\theta_0}{5}$. The resistance of the galvanometer is, then, given by [Neglect the internal resistance of battery]:

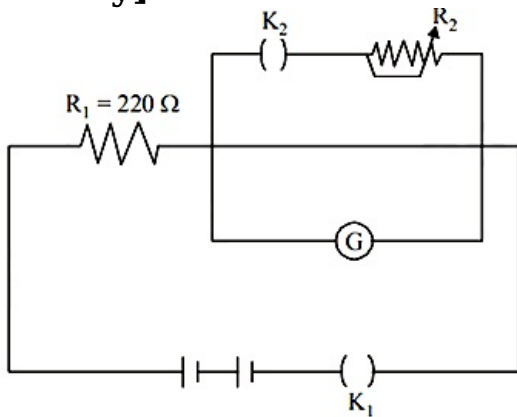

[12 Jan 2019, I]

Options:

- A. 5Ω
- B. 22Ω
- C. 25Ω
- D. 12Ω

Answer: B

Solution:

Solution:

When key K_1 is closed and key K_2 is open

$$i_g = \frac{E}{220 + R_g} = C\theta_0 \dots\dots(i)$$

When both the keys are closed

$$i_g = \left(\frac{E}{220 + \frac{5R_g}{5 + R_g}} \right) \times \frac{5}{(R_g + 5)} = \frac{C\theta_0}{5}$$

$$\Rightarrow \frac{5E}{225R_g + 1100} = \frac{C\theta_0}{5} \dots\dots(ii)$$

$$\frac{E}{220 + R_g} = C\theta_0 \dots\dots(i)$$

Dividing (i) by (ii), we get

$$\begin{aligned} \Rightarrow \frac{225R_g + 1100}{1100 + 5R_g} &= 5 \\ \Rightarrow 5500 + 25R_g &= 225R_g + 1100 \\ 200R_g &= 4400 \\ R_g &= 22\Omega \end{aligned}$$

Question113

A galvanometer, whose resistance is 50 ohm, has 25 divisions in it. When a current of 4×10^{-4} A passes through it, its needle (pointer) deflects by one division. To use this galvanometer as a voltmeter of range 2.5V, it should be connected to a resistance of :
[12 Jan 2019, II]

Options:

- A. 250 ohm
- B. 200 ohm
- C. 6200 ohm
- D. 6250 ohm

Answer: B

Solution:

Solution:

Galvanometer has 25 divisions $I_g = 4 \times 10^{-4} \times 25 = 10^{-2}$ A

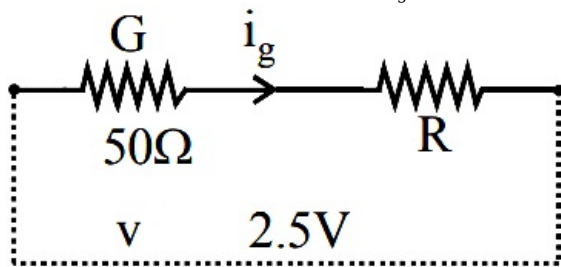

$$\begin{aligned} V &= I_g R_{net} \\ v &= I_g (G + R) \\ 2.5 &= (50 + R)10^{-2} \therefore R = 200\Omega \end{aligned}$$

Question114

A galvanometer having a resistance of 20 Ω and 30 division on both sides has figure of merit 0.005 ampere/division. The resistance that should be connected in series such that it can be used as a voltmeter upto 15 volt, is:
[11 Jan 2019, II]

Options:

- A. 100 Ω



B. 120 Ω

C. 80 Ω

D. 125 Ω

Answer: C

Solution:

Solution:

Deflection current

$$= I_{g_{\max}} = n \times k = 0.005 \times 30$$

Where, n = Number of divisions = 30 and $k = 0.005 \text{ amp/division}$

$$= 15 \times 10^{-2} = 0.15$$

$$v = I_g [20 + R]$$

$$15 = 0.15 [20 + R]$$

$$100 = 20 + R$$

$$R = 80 \Omega$$

Question115

A galvanometer having a coil resistance 100 Ω gives a full scale deflection when a current of 1 mA is passed through it. What is the value of the resistance which can convert this galvanometer into a voltmeter giving full scale deflection for a potential difference of 10 V? [8 Jan 2019, II]

Options:

A. 10 k Ω

B. 8.9 k Ω

C. 7.9 k Ω

D. 9.9 k Ω

Answer: D

Solution:

Solution:

Given,

Resistance of galvanometer, $G = 100 \Omega$ Current, $i_g = 1 \text{ mA}$

A galvanometer can be converted into voltmeter by connecting a large resistance R in series with it.

Total resistance of the combination = $G + R$

According to Ohm's law, $V = i_g(G + R)$

$$\therefore 10 = 1 \times 10^{-3}(100 + R_0)$$

$$\Rightarrow 10000 - 100 = 9900 \Omega = R_0$$

$$\Rightarrow R_0 = 9.9 \text{ k}\Omega$$

Question116



A proton, an electron, and a Helium nucleus, have the same energy. They are in circular orbits in a plane due to magnetic field perpendicular to the plane. Let r_p , r_e and r_{He} be their respective radii, then,
[10 April 2019, I]

Options:

- A. $r_e > r_p = r_{He}$
- B. $r_e < r_p = r_{He}$
- C. $r_e < r_p < r_{He}$
- D. $r_e > r_p > r_{He}$

Answer: B

Solution:

Solution:

$$\text{As } mvr = qvB \Rightarrow r = \frac{mv}{qB} = \frac{\sqrt{2mK \cdot E}}{qB}$$

$$\left[\text{As } \frac{1}{2}mv^2 = K \cdot E \right]$$

$$\Rightarrow m^2v^2 = \frac{2mK \cdot E}{}$$

$$\Rightarrow mv = \sqrt{2mK \cdot E}$$

For proton, electron and α -particle,

$$m_{He} = 4m_p \text{ and } m_p \gg m_e$$

$$\text{Also } a_{He} = 2q_p \text{ and } q_p = q_e$$

\therefore As $K E$ of all the particles is same then,

$$r \propto \frac{\sqrt{m}}{q}$$

$$\therefore r_{He} = r_p > r_e$$

Question 117

Two very long, straight, and insulated wires are kept at 90° angle from each other in xy -plane as shown in the figure.

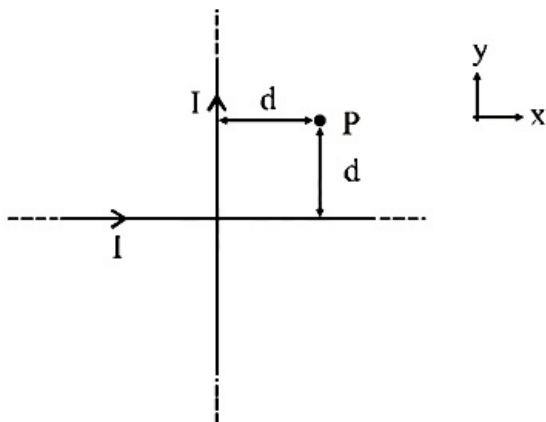

These wires carry currents of equal magnitude I , whose directions are shown in the figure. The net magnetic field at point P will be:

[12 April 2019, I]

Options:

- A. Zero
- B. $-\frac{\mu_0 I}{2\pi d}(\hat{x} + \hat{y})$
- C. $\frac{+\mu_0 I}{\pi d}(\hat{z})$
- D. $\frac{\mu_0 I}{2\pi d}(\hat{x} + \hat{y})$

Answer: A**Solution:****Solution:**

$$\begin{aligned}\vec{B} &= \vec{B}_1 + \vec{B}_2 \\ &= \frac{\mu_0}{2\pi} \cdot \left(\frac{i^o}{d} \cdot \hat{k} + \frac{i^o}{d}(-\hat{k}) \right) = 0\end{aligned}$$

Question 118

A thin ring of 10cm radius carries a uniformly distributed charge. The ring rotates at a constant angular speed of 40 rad s^{-1} about its axis, perpendicular to its plane. If the magnetic field at its centre is $3.8 \times 10^{-9} \text{ T}$, then the charge carried by the ring is close to ($\mu_0 = 4\pi \times 10^{-7} \text{ N / A}^2$).

[12 April 2019, I]**Options:**

- A. $2 \times 10^{-6} \text{ C}$
- B. $3 \times 10^{-5} \text{ C}$
- C. $4 \times 10^{-5} \text{ C}$
- D. $7 \times 10^{-6} \text{ C}$

Answer: B**Solution:****Solution:**

If q is the charge on the ring, then

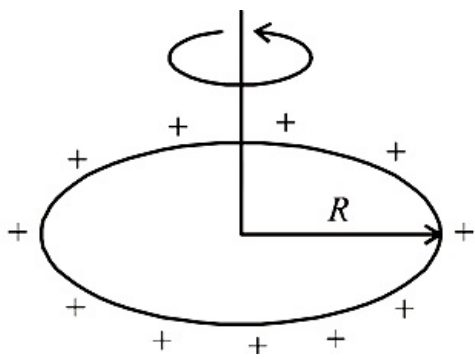

$$i = \frac{q}{T} = \frac{q\omega}{2\pi}$$

Magnetic field,

$$B = \frac{\mu_0 i}{2R}$$

$$= \frac{\mu_0 \left(\frac{q\omega}{2\pi} \right)}{2R}$$

$$\text{or } 3.8 \times 10^{-9} = \left(\frac{\mu_0}{4\pi} \right) \frac{q\omega}{R} = (10^{-7}) \frac{q \times 40\pi}{0.10}$$

$$\therefore q = 3 \times 10^{-5} \text{C}$$

Question 119

Find the magnetic field at point P due to a straight line segment AB of length 6cm carrying a current of 5A. (See figure)

($\mu_0 = 4\pi \times 10^{-7} \text{N} - \text{A}^{-2}$)

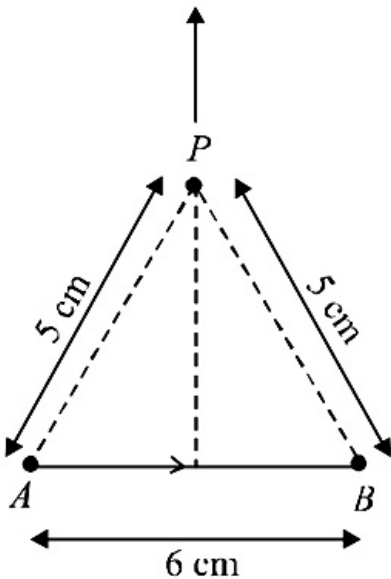

[12 April 2019, II]

Options:

A. $2.0 \times 10^{-5} \text{T}$

B. $1.5 \times 10^{-5} \text{T}$

C. $3.0 \times 10^{-5} \text{T}$

D. $2.5 \times 10^{-5} \text{T}$

Answer: B

Solution:

$$B = \frac{\mu_0}{4\pi} \frac{i}{r} (\sin \alpha + \sin \beta)$$

$$\text{Here } r = \sqrt{5^2 - 3^2} = 4\text{cm}$$

$$\alpha = \beta = 37^\circ$$

$$\therefore B = 10^{-7} \times \frac{5}{4} 2 \sin 37^\circ = 1.5 \times 10^{-5}\text{T}$$

Question120

The magnitude of the magnetic field at the center of an equilateral triangular loop of side 1m which is carrying a current of 10 A is :

[Take $\mu_0 = 4\pi \times 10^{-7}\text{N A}^{-2}$]

[10 April 2019, II]

Options:

A. $18\mu\text{T}$

B. $9\mu\text{T}$

C. $3\mu\text{T}$

D. $1\mu\text{T}$

Answer: A

Solution:

$$r = \left(\frac{1}{3}\right)(a \sin 60)$$

$$r = \frac{a}{3} \times \frac{\sqrt{3}}{2} = \left(\frac{a}{2\sqrt{3}}\right)$$

$$B_0 = 3 \left[\frac{\mu_0 I}{4\pi r} (\sin 60^\circ + \sin 60^\circ) \right]$$

$$= \frac{3\mu_0 I}{4\pi \left(\frac{a}{2\sqrt{3}}\right)} \times (2) \left(\frac{\sqrt{3}}{2}\right) = \frac{9}{2} \left(\frac{\mu_0 I}{\pi a}\right)$$

$$= \frac{9 \times 2 \times 10^{-7} \times 10}{1} = 18\mu\text{T}$$

Question121



A square loop is carrying a steady current I and the magnitude of its magnetic dipole moment is m . If this square loop is changed to a circular loop and it carries the same current, the magnitude of the magnetic dipole moment of circular loop will be :

[10 April 2019, II]

Options:

- A. $\frac{m}{\pi}$
- B. $\frac{3m}{\pi}$
- C. $\frac{2m}{\pi}$
- D. $\frac{4m}{\pi}$

Answer: D

Solution:

Solution:

Let a be the area of the square and r be the radius of circular loop.

$$2\pi r = 4a \Rightarrow r = \left(\frac{2a}{\pi}\right)$$

For square $M = (I)a^2$

For circular loop $M_1 = (I)\pi r^2$

$$M_1 = (I)(\pi) \left(\frac{4a^2}{\pi^2}\right)$$

$$M_1 = \frac{4Ia^2}{\pi}$$

$$M_1 = \frac{4M}{\pi} (\because M = I a^2)$$

Question 122

Two wires A & B are carrying currents I_1 and I_2 as shown in the figure. The separation between them is d . A third wire C carrying a current I is to be kept parallel to them at a distance x from A such that the net force acting on it is zero. The possible values of x are :

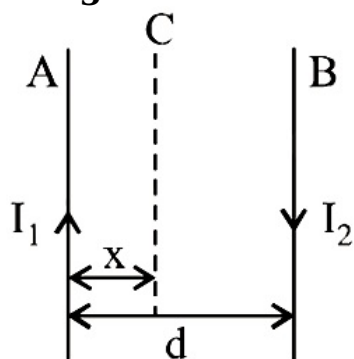

[10 April 2019, I]

Options:

- A. $x = \left(\frac{I_1}{I_1 - I_2} \right) d$ and $x = \frac{I_2}{(I_1 + I_2)} d$
- B. $x = \left(\frac{I_2}{(I_1 + I_2)} \right) d$ and $x = \left(\frac{I_2}{(I_1 - I_2)} \right) d$
- C. $x = \left(\frac{I_1}{(I_1 + I_2)} \right) d$ and $x = \left(\frac{I_2}{(I_1 - I_2)} \right) d$
- D. $x = \pm \frac{I_1 d}{(I_1 - I_2)}$

Answer: D

Solution:

Solution:

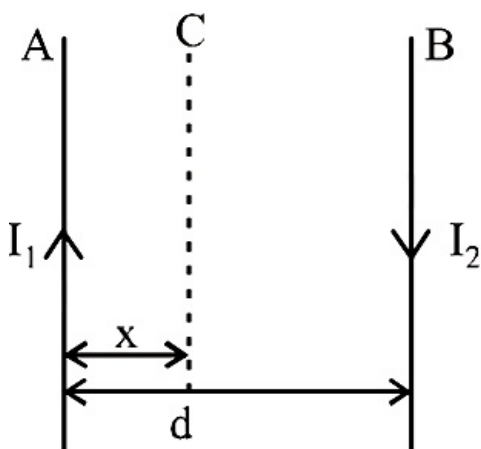

As net force on the third wire C is zero.

$$\Rightarrow \vec{F} = \frac{\mu_0 I_1}{2\pi x} + \frac{\mu_0 I_2}{2\pi(d-x)} = 0$$

$$\frac{\mu_0 I_1}{2\pi x} = \frac{\mu_0 I_2}{2\pi(x-d)}$$

$$I_1 x - I_1 d = I_2 x$$

$$x = \frac{I_1 d}{I_1 - I_2}$$

Two cases may be possible if $I_1 > I_2$ or $I_2 > I_1$

Question123

A rectangular coil (Dimension 5 cm × 2.5 cm) with 100 turns, carrying a current of 3 A in the clock-wise direction, is kept centered at the origin and in the X-Z plane. A magnetic field of 1 T is applied along X-axis. If the coil is tilted through 45° about Z-axis, then the torque on the coil is: [9 April 2019 I]

Options:

- A. 0.38 Nm
- B. 0.55 Nm

C. 0.42 Nm

D. 0.27 Nm

Answer: D

Solution:

Solution:

$$\begin{aligned}\tau &= M B \sin 45^\circ = N (iA) B \sin 45^\circ \\ &= 100 \times 3(5 \times 2.5) \times 10^{-4} \times 1 \times \frac{1}{\sqrt{2}} \\ &= 0.27 \text{ N} \cdot \text{m}\end{aligned}$$

Question 124

A rigid square of loop of side 'a' and carrying current I_2 is lying on a horizontal surface near a long current I_1 carrying wire in the same plane as shown in figure. The net force on the loop due to the wire will be:

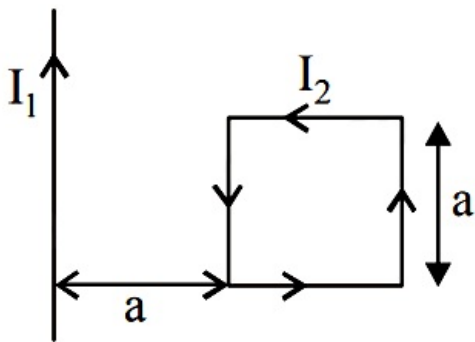

[9 April 2019 I]

Options:

- A. Repulsive and equal to $\frac{\mu_0 I_1 I_2}{2\pi}$
- B. Attractive and equal to $\mu_0 I_1 I_2 3\pi$
- C. Repulsive and equal to $\frac{\mu_0 I_1 I_2}{4\pi}$
- D. Zero

Answer: C

Solution:

Solution:

$$F = \frac{\mu_0}{2\pi} \left(\frac{i_1 i_2}{a} - \frac{i_1 i_2}{2a} \right) \times a = \frac{\mu_0 i_1 i_2}{4\pi}$$

Question 125

A circular coil having N turns and radius r carries a current I . It is held in the XZ plane in a magnetic field B . The torque on the coil due to the magnetic field is :

[8 April 2019 I]

Options:

- A. $\frac{Br^2I}{\pi N}$
- B. $B\pi r^2 I N$
- C. $\frac{B\pi r^2 I}{N}$
- D. Zero

Answer: B

Solution:

Solution:

$$\begin{aligned}
 |\vec{\tau}| &= |\vec{\mu} \times \vec{B}| [\mu = NIA] \\
 &= NIA \times B \sin 90^\circ [A = \pi r^2] \\
 \Rightarrow \tau &= N I \pi r^2 B
 \end{aligned}$$

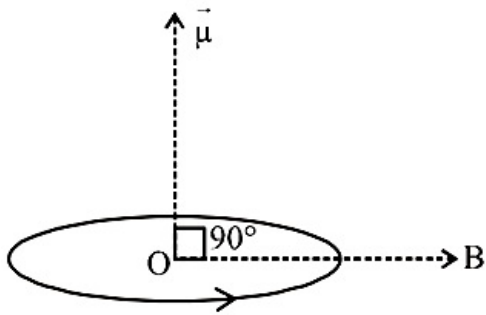

Question 126

A galvanometer of resistance 100Ω has 50 divisions on its scale and has sensitivity of $20\mu A/\text{division}$. It is to be converted to a voltmeter with three ranges, of $0 - 2V$, $0 - 10V$ and $0 - 20V$. The appropriate circuit to do so is :

[12 April 2019, I]

Options:

A.

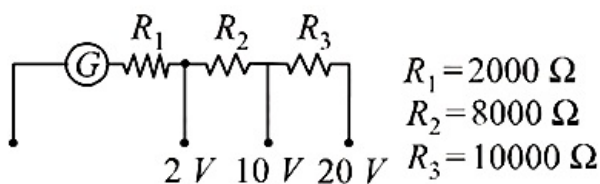

$$\begin{aligned}
 R_1 &= 2000 \Omega \\
 R_2 &= 8000 \Omega \\
 R_3 &= 10000 \Omega
 \end{aligned}$$

B.



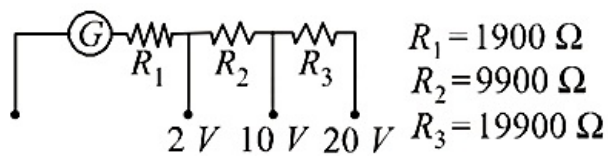

C.

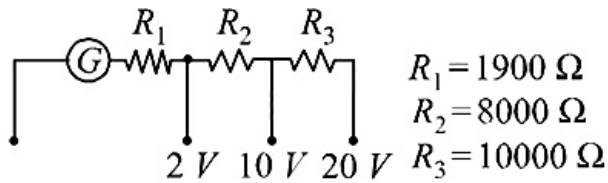

D.

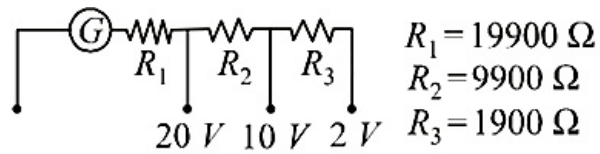

Answer: C

Solution:

$$i_n = 20 \times 50 = 1000 \mu\text{A} = 1 \text{mA}$$

$\therefore i_g(G + R)$, we have

$$2 = 10^{-3}(100 + R_1)$$

$$R_1 = 1900 \Omega$$

when, $V = 10$ volt

$$10 = 10^{-3}(100 + R_2 + R_1)$$

$$10000 = (100 + R_2 + 1900)$$

$$\therefore R_2 = 8000 \Omega$$

Question 127

A moving coil galvanometer, having a resistance G , produces full scale deflection when a current I_g flows through it. This galvanometer can be converted into (i) an ammeter of range 0 to I_0 ($I_0 > I_g$) by connecting a shunt resistance R_A to it and (ii) into a voltmeter of range 0 to V ($V = GI_0$) by connecting a series resistance R_V to it. Then, [12 April 2019, II]

Options:

A. $R_A R_V = G^2 \left(\frac{I_0 - I_g}{I_g} \right)$ and $\frac{R_A}{R_V} = \left(\frac{I_0 - I_g}{I_0 - I_g} \right)^2$

B. $R_A R_V = G^2$ and $\frac{R_A}{R_V} = \left(\frac{I_0 - I_g}{I_0 - I_g} \right)^2$

C. $R_A R_V = G^2 \left(\frac{I_0 - I_g}{I_0 - I_g} \right)$ and $\frac{R_A}{R_V} = \left(\frac{I_0 - I_g}{I_0 - I_g} \right)^2$

$$D. R_A R_V = G^2 \text{ and } \frac{R_A}{R_V} = \frac{I_g}{(I_0 - I_g)}$$

Answer: B

Solution:

Solution:

In an ammeter,

$$i_g = i_0 \frac{R_A}{R_A + G}$$

and for voltmeter,

$$V = i_g(G + R_V) = Gi_0$$

On solving above equations, we get

$$R_A R_V = G^2$$

$$\text{and } \frac{R_A}{R_V} = \left(\frac{i_g}{i_0 - i_g} \right)^2$$

Question128

A moving coil galvanometer allows a full scale current of 10^{-4} A. A series resistance of $2M \Omega$ is required to convert the above galvanometer into a voltmeter of range $0 - 5V$. Therefore the value of shunt resistance required to convert the above galvanometer into an ammeter of range $0 - 10mA$ is :

[10 April 2019, I]

Options:

A. 500Ω

B. 100Ω

C. 200Ω

D. 10Ω

E. (Bonus)

Answer: E

Solution:

Solution:

$$v = i_g(R + G)$$

$$\Rightarrow 5 = 10^{-4}(2 \times 10^6 + x)$$

$$x = -195 \times 10^4 \Omega$$

Question129

A moving coil galvanometer has resistance 50Ω and it indicates full deflection at 4 mA current. A voltmeter is made using this galvanometer



and a $5\text{k}\Omega$ resistance. The maximum voltage, that can be measured using this voltmeter, will be close to:
[9 April 2019 I]

Options:

- A. 40V
- B. 15V
- C. 20V
- D. 10V

Answer: C

Solution:

Solution:

$$V = i_g(G + R) = 4 \times 10^{-3}(50 + 5000) = 20\text{V}$$

Question130

A moving coil galvanometer has a coil with 175 turns and area 1cm^2 . It uses a torsion band of torsion constant $10^{-6}\text{N} - \text{m} / \text{rad}$. The coil is placed in a magnetic field B parallel to its plane. The coil deflects by 1° for a current of 1mA. The value of B (in Tesla) is approximately:
[9 April 2019, II]

Options:

- A. 10^{-4}
- B. 10^{-2}
- C. 10^{-1}
- D. 10^{-3}

Answer: D

Solution:

Solution:

$$C\theta = N BiA \sin 90^\circ$$

$$\text{or } 10^{-6} \left(\frac{\pi}{180} \right) = 175B(10^{-3}) \times 10^{-4}$$

$$\therefore B = 10^{-3}\text{T}$$

Question131

The resistance of a galvanometer is 50 ohm and the maximum current



which can be passed through it is 0.002 A. What resistance must be connected to it order to convert it into an ammeter of range 0 – 0.5A?
[9 April 2019, II]

Options:

- A. 0.5 ohm
- B. 0.002 ohm
- C. 0.02 ohm
- D. 0.2 ohm

Answer: D

Solution:

Solution:

$$\text{Using, } i_g = i \frac{S}{S + G}$$

$$0.002 = 0.5 \frac{S}{S + 50}$$

On solving, we get

$$S = \frac{100}{498} \approx 0.2\Omega$$

Question132

A particle having the same charge as of electron moves in a circular path of radius 0.5cm under the influence of a magnetic field of 0.5T . If an electric field of 100V / mmakes it to move in a straight path then the mass of the particle is (Given charge of electron = $1.6 \times 10^{-19}\text{C}$)
[12 April 2019, I]

Options:

- A. $9.1 \times 10^{-31}\text{kg}$
- B. $1.6 \times 10^{-27}\text{kg}$
- C. $1.6 \times 10^{-19}\text{kg}$
- D. $2.0 \times 10^{-24}\text{kg}$

Answer: D

Solution:

Solution:

As particle is moving along a circular path

$$\therefore R = \frac{mv}{qB} \dots\dots(i)$$

Path is straight line, then $qE = qvB$

$$E = vB \Rightarrow v = \frac{E}{B} \dots\dots(ii)$$

From equation (i) and (ii)



$$m = \frac{qB^2R}{E} = \frac{1.6 \times 10^{-19} \times (0.5)^2 \times 0.5 \times 10^{-2}}{100}$$

$$\therefore m = 2.0 \times 10^{-24} \text{kg}$$

Question133

An electron, moving along the x -axis with an initial energy of 100eV , enters a region of magnetic field $\vec{B} = (1.5 \times 10^{-3} \text{T}) \hat{k}$ at S (see figure). The field extends between $x = 0$ and $x = 2\text{cm}$. The electron is detected at the point Q on a screen placed 8cm away from the point S. The distance d between P and Q (on the screen) is:
(Electron's charge = $1.6 \times 10^{-19} \text{C}$, mass of electron = $9.1 \times 10^{-31} \text{kg}$)

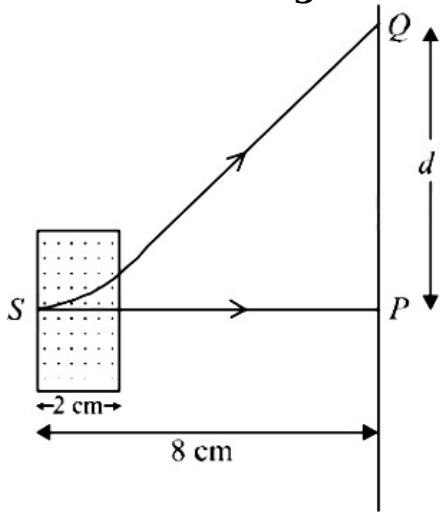

[12 April 2019, II]

Options:

- A. 11.65cm
- B. 12.87cm
- C. 1.22cm
- D. 2.25cm

Answer: B

Solution:

Question134

An electron, a proton and an alpha particle having the same kinetic energy are moving in circular orbits of radii r_e , r_p , r_α respectively in a uniform magnetic field B. The relation between r_e , r_p , r_α is :

[2018]

Options:

A. $r_e > r_p = r_\alpha$

B. $r_e < r_p = r_\alpha$

C. $r_e < r_p < r_\alpha$

D. $r_e < r_\alpha < r_p$

Answer: B**Solution:****Solution:**

As we know, radius of circular path in magnetic field $r = \frac{\sqrt{2Km}}{qB}$

For electron, $r_e = \frac{\sqrt{2Km_e}}{eB}$ (i)

For proton, $r_p = \frac{\sqrt{2Km_p}}{eB}$ (ii)

For α particle, $r_\alpha = \frac{\sqrt{2Km_a}}{q_\alpha B} = \frac{\sqrt{2K \cdot 4m_p}}{2eB} = \frac{\sqrt{2Km_p}}{eB}$ (iii)

$\therefore r_e < r_p = r_\alpha$ ($\because m_e < m_p$)

Question135

The dipole moment of a circular loop carrying a current I , is m and the magnetic field at the centre of the loop is B_1 . When the dipole moment is doubled by keeping the current constant, the magnetic field at the centre of the loop is B_2 . The ratio $\frac{B_1}{B_2}$ is:

[2018]**Options:**

A. 2

B. $\sqrt{3}$

C. $\sqrt{2}$

D. $\frac{1}{\sqrt{2}}$

Answer: C**Solution:**

at the centre of loop, $B_1 = \frac{\mu_0 I}{2R}$

Dipole moment of circular loop is $m = IA$

$m_1 = I \cdot A = I \cdot \pi R^2$ { $R =$ Radius of the loop }

If moment is doubled (keeping current constant) R becomes $\sqrt{2}R$



$$m_2 = I \cdot \pi(\sqrt{2}R)^2 = 2 \cdot I \pi R^2 = 2m_1$$

$$B_2 = \frac{\mu_0 I}{2(\sqrt{2}R)}$$

$$\therefore \frac{B_1}{B_2} = \frac{\frac{\mu_0 I}{2R}}{\frac{\mu_0 I}{2(\sqrt{2}R)}} = \sqrt{2}$$

Question136

A Helmholtz coil has pair of loops, each with N turns and radius R . They are placed coaxially at distance R and the same current I flows through the loops in the same direction. The magnitude of magnetic field at P , midway between the centres A and C , is given by (Refer to figure):

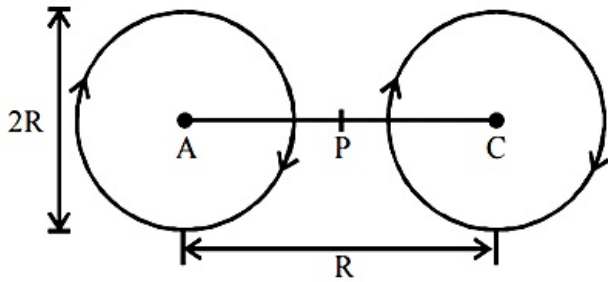

[Online April 15, 2018]

Options:

A. $\frac{4N \mu_0 I}{5^{3/2}R}$

B. $\frac{8N \mu_0 I}{5^{3/2}R}$

C. $\frac{4N \mu_0 I}{5^{1/2}R}$

D. $\frac{8N \mu_0 I}{5^{1/2}R}$

Answer: B

Solution:

Solution:

Point P is situated at the mid-point of the line joining the centres of the circular wires which have same radii (R).

The magnetic fields (\vec{B}) at P due to the currents in the wires are in same direction.

Magnitude of magnetic field at point, P

$$B = 2 \left\{ \frac{\mu_0 N I R^2}{2 \left(R^2 + \frac{R^2}{4} \right)^{3/2}} \right\} = \frac{\mu_0 N I R^2}{\frac{5^{3/2}}{8}} = \frac{8\mu_0 N I}{5^{3/2}R}$$

Question137

A current of 1A is flowing on the sides of an equilateral triangle of side

4.5×10^{-2} m. The magnetic field at the centre of the triangle will be:
[Online April 15, 2018]

Options:

- A. 4×10^{-5} W b / m²
- B. Zero
- C. 2×10^{-5} W b / m²
- D. 8×10^{-5} W b / m²

Answer: A

Solution:

Solution:

Here, side of the triangle, $l = 4.5 \times 10^{-2}$ m, current, $I = 1$ A magnetic field at the centre of the triangle 'O' B = ?

From figure, $\tan 60^\circ = \sqrt{3} = \frac{1}{2d}$

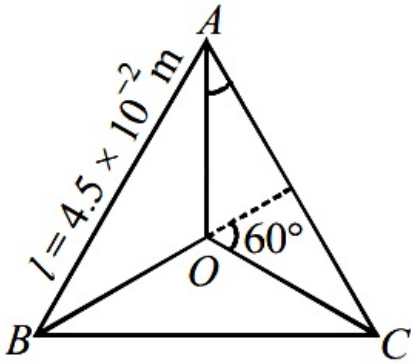

$$\Rightarrow d = \frac{1}{2\sqrt{3}} = \left(\frac{4.5 \times 10^{-2}}{2\sqrt{3}} \right) \text{ m}$$

$$\text{Magnetic field, } B = \frac{\mu_0 i}{4\pi d} (\cos \theta_1 + \cos \theta_2)$$

Putting value of $\mu_0 = 4\pi \times 10^{-7}$ and θ_1 and θ_2 we will get $B = 4 \times 10^{-5}$ W b / m²

Question 138

A charge q is spread uniformly over an insulated loop of radius r . If it is rotated with an angular velocity ω with respect to normal axis then the magnetic moment of the loop is
[Online April 16, 2018]

Options:

- A. $\frac{1}{2}q\omega r^2$
- B. $\frac{4}{3}q\omega r^2$
- C. $\frac{3}{2}q\omega r^2$
- D. $q\omega r^2$

Answer: A

Solution:

$$\text{moment, } \mu = I A = \frac{qV}{2\pi r}(\pi r^2)$$

$$\text{or, } \mu = \frac{qr\omega}{2\pi r}(\pi r^2) = \frac{1}{2}qr^2\omega$$

Question139

In a circuit for finding the resistance of a galvanometer by half deflection method, a 6 V battery and a high resistance of 11k Ω are used. The figure of merit of the galvanometer 60 μ A/division. In the absence of shunt resistance, the galvanometer produces a deflection of $\theta = 9$ divisions when current flows in the circuit. The value of the shunt resistance that can cause the deflection of $\theta/2$, is closest to [Online April 16, 2018]

Options:

- A. 55 Ω
- B. 110 Ω
- C. 220 Ω
- D. 550 Ω

Answer: B

Solution:

Figure of merit of a galvanometer is the current required to produce a deflection of one division in the galvanometer i.e.,
figure of merit = $\frac{I}{\theta}$

$$I = \frac{\varepsilon}{R+G} \quad G = \frac{1}{9} \text{K } \Omega$$

$$\frac{1}{2} = \frac{\varepsilon}{R + \frac{GS}{G+S}} \times \frac{S}{S+G} \Rightarrow \frac{1}{2} = \frac{\varepsilon S}{R(S+G) + GS}$$

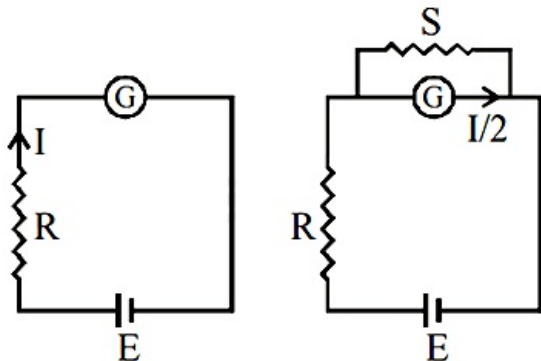

$$S = \frac{11 \times 10^3 \times \frac{1}{2} \times 10^2 \times 270 \times 10^{-6}}{6 - \left(\frac{6}{2}\right)} = 110\Omega$$

Question140

A galvanometer with its coil resistance 25Ω requires a current of 1mA for its full deflection. In order to construct an ammeter to read up to a current of 2A , the approximate value of the shunt resistance should be [Online April 16,2018]

Options:

- A. $2.5 \times 10^{-2}\Omega$
- B. $1.25 \times 10^{-3}\Omega$
- C. $2.5 \times 10^{-3}\Omega$
- D. $1.25 \times 10^{-2}\Omega$

Answer: D

Solution:

Solution:

According to question, current through galvanometer,

$$I_a = 1\text{mA}$$

Current through shunt $(I - I_a) = 2\text{A}$

Galvanometer resistance $R_g = 25\Omega$

Resistance of shunt, $S = ?$

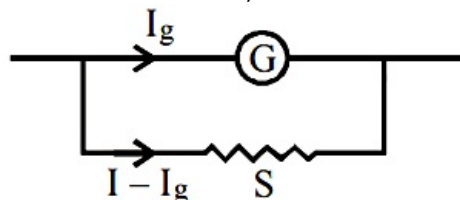

$$I_a R_g = (I - I_a) S$$

$$\Rightarrow S = \frac{10^{-3} \times 25}{2}$$

$$S \approx 1.25 \times 10^{-2}\Omega$$

Question141

A negative test charge is moving near a long straight wire carrying a current. The force acting on the test charge is parallel to the direction of the current. The motion of the charge is : [Online April 9, 2017]

Options:

- A. away from the wire
- B. towards the wire
- C. parallel to the wire along the current
- D. parallel to the wire opposite to the current



Answer: B

Solution:

Solution:

The force is parallel to the direction of current in magnetic field,

hence $F = q(v \times B)$

According to Fleming's left hand rule,

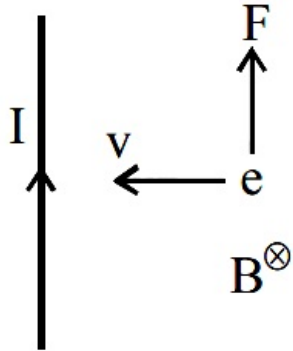

we have, the direction of motion of charge is towards the wire.

Question 142

In a certain region static electric and magnetic fields exist. The magnetic field is given by $\vec{B} = B_0(\hat{i} + 2\hat{j} - 4\hat{k})$. If a test charge moving with a velocity $\vec{v} = v_0(3\hat{i} - \hat{j} + 2\hat{k})$ experiences no force in that region, then the electric field in the region, in SI units, is :
[Online April 8, 2017]

Options:

A. $\vec{E} = -v_0 B_0(3\hat{i} - 2\hat{j} - 4\hat{k})$

B. $\vec{E} = -v_0 B_0(\hat{i} + \hat{j} + 7\hat{k})$

C. $\vec{E} = v_0 B_0(14\hat{j} + 7\hat{k})$

D. $\vec{E} = -v_0 B_0(14\hat{j} + 7\hat{k})$

Answer: D

Solution:

Solution:

According to question, as the test charge experiences no net force in that region i.e., sum of electric force ($F_e = q\vec{E}$)

and magnetic forces [$F_m = q(\vec{v} \times \vec{B})$] will be zero.

Hence, $F_e + F_m = 0$

$$F_e = -q(\vec{v} \times \vec{B})$$

$$= -B_0 v_0 [(3\hat{i} - \hat{j} + 2\hat{k}) \times (\hat{i} + 2\hat{j} - 4\hat{k})]$$

$$= -B_0 v_0 (14\hat{j} + 7\hat{k})$$

Question143

A uniform magnetic field B of 0.3 T is along the positive Z direction. A rectangular loop ($abcd$) of sides $10\text{ cm} \times 5\text{ cm}$ carries a current I of 12 A . Out of the following different orientations which one corresponds to stable equilibrium ?

[Online April 9, 2017]

Options:

A.

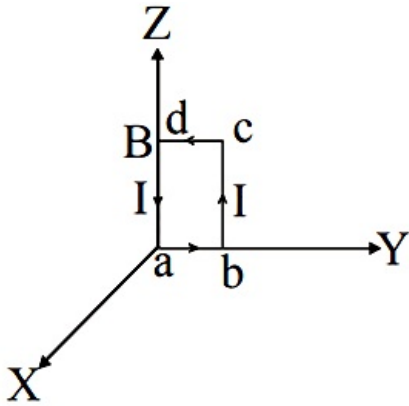

B.

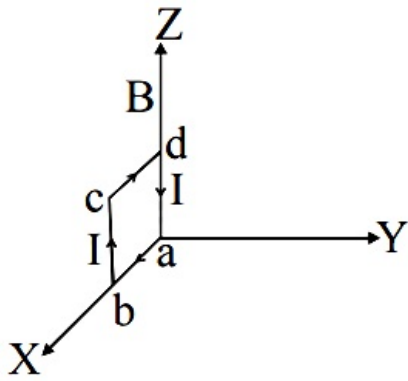

C.

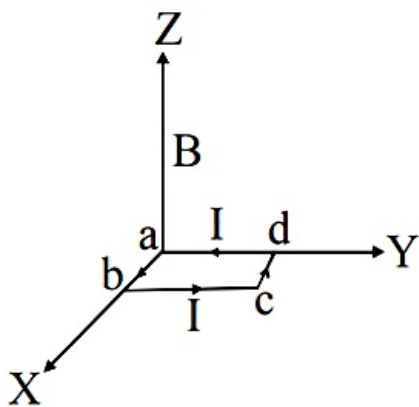

D.

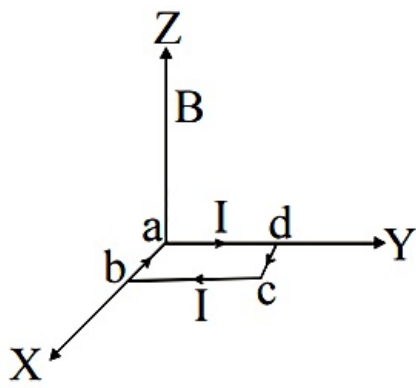

Answer: C

Solution:

Solution:

Magnetic moment of current carrying rectangular loop of area A is given by $\vec{M} = NIA$
 magnetic moment of current carrying coil is a vector and its direction is given by right hand thumb rule, for rectangular loop, \vec{B} at centre due to current in loop and \vec{M} are always parallel.

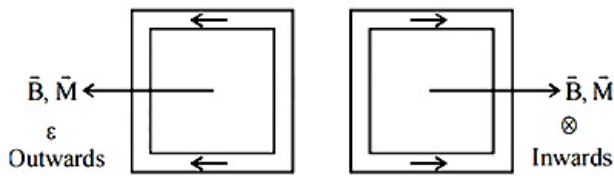

Hence, (c) corresponds to stable equilibrium.

Question144

When a current of 5 mA is passed through a galvanometer having a coil of resistance 15Ω , it shows full scale deflection. The value of the resistance to be put in series with the galvanometer to convert it into to voltmeter of range 0 – 10V is [2017]

Options:

- A. $2.535 \times 10^3\Omega$
- B. $4.005 \times 10^3\Omega$
- C. $1.985 \times 10^3\Omega$
- D. $2.045 \times 10^3\Omega$

Answer: C

Solution:

Solution:

Given : Current through the galvanometer,

$$i_g = 5 \times 10^{-3}\text{A}$$

Galvanometer resistance, $G = 15\Omega$

Let resistance R to be put in series with the galvanometer to convert it into a voltmeter.

$$V = i_g(R + G)$$

$$10 = 5 \times 10^{-3}(R + 15)$$



$$\therefore R = 2000 - 15 = 1985 = 1.985 \times 10^3 \Omega$$

Question 145

Consider a thin metallic sheet perpendicular to the plane of the paper moving with speed 'v' in a uniform magnetic field B going into the plane of the paper (See figure). If charge densities σ_1 and σ_2 are induced on the left and right surfaces, respectively, of the sheet then (ignore fringe effects):

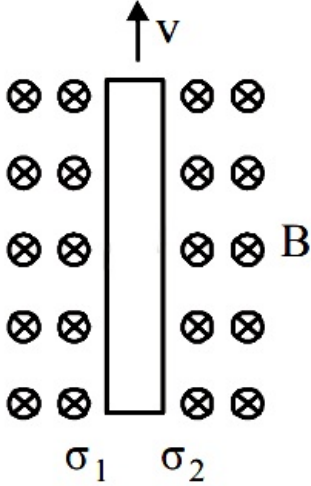

[Online April 10, 2016]

Options:

- A. $\sigma_1 = \frac{-\epsilon_0 vB}{2}, \sigma_2 = \frac{\epsilon_0 vB}{2}$
- B. $\sigma_1 = \epsilon_0 vB, \sigma_2 = -\epsilon_0 vB$
- C. $\sigma_1 = \frac{\epsilon_0 vB}{2}, \sigma_2 = \frac{-\epsilon_0 vB}{2}$
- D. $\sigma_1 = \sigma_2 = \epsilon_0 vB$

Answer: B

Solution:

Solution:

$$\because F = qE \text{ and } F = qvB$$

$$\therefore E = vB$$

$$\text{And Gauss's law in Electrostatics } E = \frac{\sigma}{\epsilon_0}$$

$$E = \frac{\sigma}{\epsilon_0} = vB \Rightarrow \sigma = \epsilon_0 vB$$

$$\sigma_1 = -\sigma_2$$

Question 146

Two identical wires A and B, each of length 'l', carry the same current I.

Wire A is bent into a circle of radius R and wire B is bent to form a square of side a'. If B_A and B_B are the values of magnetic field at the centres of the circle and square respectively, then the ratio $\frac{B_A}{B_B}$ is:

[2016]

Options:

A. $\frac{\pi^2}{16}$

B. $\frac{\pi^2}{8\sqrt{2}}$

C. $\frac{\pi^2}{8}$

D. $\frac{\pi^2}{16\sqrt{2}}$

Answer: B

Solution:

Solution:

Case (a):

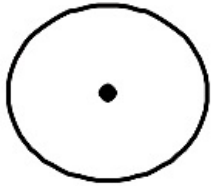

$$B_A = \frac{\mu_0 I}{4\pi R} \times 2\pi = \frac{\mu_0 I}{4\pi l / 2\pi} \times 2\pi (\because 2\pi R = l)$$

$$= \frac{\mu_0 I}{4\pi l} \times (2\pi)^2$$

Case (b) :

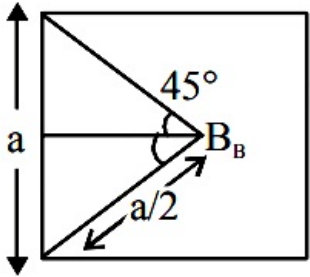

$$B_B = 4 \times \frac{\mu_0 I}{4\pi a / 2} [\sin 45^\circ + \sin 45^\circ]$$

$$= 4 \times \frac{\mu_0 I}{4\pi} \times \frac{1}{1/8} \times \frac{2}{\sqrt{2}} = \frac{\mu_0 I}{4\pi l} \times \frac{64}{\sqrt{2}} = \frac{\mu_0 I}{4\pi l} 32\sqrt{2} [4a = l]$$

$$\Rightarrow \frac{B_A}{B_B} = \frac{\pi^2}{8\sqrt{2}}$$

Question 147

A galvanometer having a coil resistance of 100Ω gives a full scale deflection, when a current of 1 mA is passed through it. The value of the resistance, which can convert this galvanometer into ammeter giving a

**full scale deflection for a current of 10 A, is :
[2016]**

Options:

- A. 0.1Ω
- B. 3Ω
- C. 0.01Ω
- D. 2Ω

Answer: C

Solution:

Solution:

$$I_g G = (I - I_g)S$$

$$\therefore 10^{-3} \times 100 = (10 - 10^{-3}) \times S$$

$$\therefore S \approx 0.01 \Omega$$

Question148

A 50Ω resistance is connected to a battery of $5V$. A galvanometer of resistance 100Ω is to be used as an ammeter to measure current through the resistance, for this a resistance r_s is connected to the galvanometer. Which of the following connections should be employed if the measured current is within 1% of the current without the ammeter in the circuit?

[Online April 9,2016]

Options:

- A. $r_s = 0.5 \Omega$ in series with the galvanometer
- B. $r_s = 1 \Omega$ in series with galvanometer
- C. $r_s = 1 \Omega$ in parallel with galvanometer
- D. $r_s = 0.5 \Omega$ in parallel with the galvanometer.

Answer: D

Solution:

Solution:

$$\text{As we know, } I = \frac{V}{R} = \frac{5}{50} = 0.1$$

$$I' = 0.099$$

When Galvanometer is connected

$$R_{eq} = 50 + \frac{100S}{100 + S} = \frac{V}{I}$$

$$\Rightarrow \frac{100S}{100 + S} = \frac{5}{0.099} - 50$$



$$\Rightarrow \frac{100S}{100 + S} = 50.50 - 50 \Rightarrow \frac{100S}{100 + S} = 0.5$$

$$\Rightarrow 100S = 50 + 0.5S \Rightarrow 99.5S = 50$$

$$S = \frac{50}{99.05} = 0.5\Omega$$

So, shunt of resistance = 0.5Ω is connected in parallel with the galvanometer.

Question 149

To know the resistance G of a galvanometer by half deflection method, a battery of emf V_E and resistance R is used to deflect the galvanometer by angle θ . If a shunt of resistance S is needed to get half deflection then G , R and S related by the equation:
[Online April 9, 2016]

Options:

A. $S(R + G) = RG$

B. $2S(R + G) = RG$

C. $2G = S$

D. $2S = G$

Answer: A

Solution:

Solution:

According to Ohm's Law, $I = \frac{V}{R}$

$$I_g = \frac{V}{R + G}$$

where, I_g - Galvanometer current, G - Galvanometer resistance

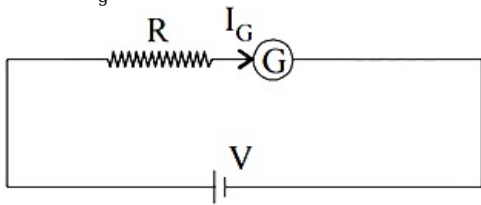

When shunt of resistance S is connected parallel to the Galvanometer then $G = \frac{GS}{G + S}$

$$\therefore I = \frac{V}{R + \frac{GS}{G + S}}$$

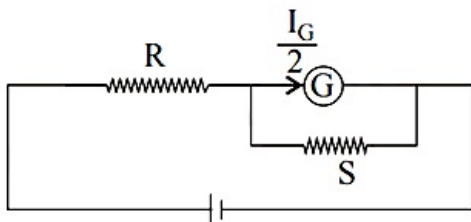

Equal potential difference is given by

$$I'_g G = (I - I'_g) S$$

$$I'_g (G + S) = I S$$

$$\Rightarrow \frac{I_g}{2} = \frac{I S}{G + S}$$



$$\Rightarrow \frac{V}{2(R+G)} = \frac{V}{R + \frac{GS}{G+S}} \times \frac{S}{G+S}$$

$$\Rightarrow \frac{1}{2(R+G)} = \frac{S}{R(G+S) + GS}$$

$$\Rightarrow R(G+S) + GS = 2S(R+G)$$

$$\Rightarrow RG + RS + GS = 2S(R+G)$$

$$\Rightarrow RG = 2S(R+G) - S(R+G)$$

$$\therefore RG = S(R+G)$$

Question150

A proton (mass m) accelerated by a potential difference V flies through a uniform transverse magnetic field B . The field occupies a region of space by width ' d '. If α be the angle of deviation of proton from initial direction of motion (see figure), the value of $\sin \alpha$ will be

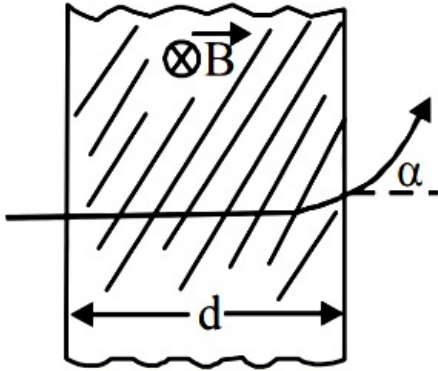

[Online April 10, 2015]

Options:

A. $qV \sqrt{\frac{Bd}{2m}}$

B. $\frac{B}{2} \sqrt{\frac{qd}{mV}}$

C. $\frac{B}{d} \sqrt{\frac{q}{2mV}}$

D. $Bd \sqrt{\frac{q}{2mV}}$

Answer: D

Solution:

Solution:

From figure, $\sin \alpha = d / R$



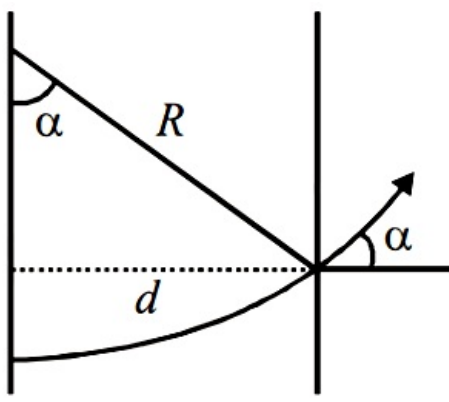

And we know, $\frac{mv^2}{R} = qvB$

$$\Rightarrow R = \frac{mv}{qB}$$

$$\therefore \sin \alpha = \frac{d q B}{mv}$$

$$\sin \alpha = Bd \sqrt{\frac{q}{2mV}} \left[\because qV = \frac{1}{2}mv^2 \right]$$

Question 151

Two long current carrying thin wires, both with current I , are held by insulating threads of length L and are in equilibrium as shown in the figure, with threads making an angle ' θ ' with the vertical. If wires have mass λ per unit length then the value of I is :

(g = gravitational acceleration)

tion) [2015]

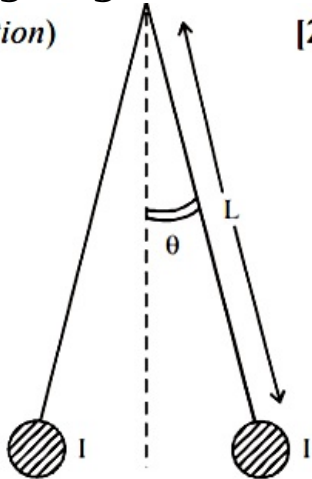

[2015]

Options:

A. $2 \sqrt{\frac{\pi g L}{\mu_0} \tan \theta}$

B. $2 \sqrt{\frac{\pi \lambda g L}{\mu_0} \tan \theta}$

C. $\sin \theta \sqrt{\frac{\pi \lambda g L}{\mu_0 \cos \theta}}$

D. $2 \sin \theta \sqrt{\frac{\pi \lambda g L}{\mu_0 \cos \theta}}$

Answer: D

Solution:

Solution:

Let us consider 'l' length of current carrying wire. At equilibrium
 $T \cos \theta = \lambda gl$

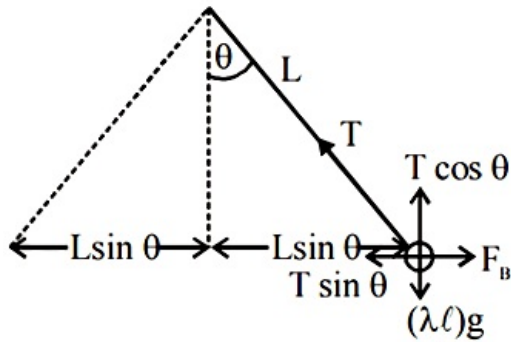

$$\text{and } T \sin \theta = \frac{\mu_0 I^2 l}{2\pi 2L \sin \theta} \left[\because \frac{F_B}{l} = \frac{\mu_0 2I \times I}{4\pi 2l \sin \theta} \right]$$

$$\text{Therefore, } I = 2 \sin \theta \sqrt{\frac{\rho l g L}{\mu_0 \cos \theta}}$$

Question152

Two coaxial solenoids of different radius carry current I in the same direction. \vec{F}_1 be the magnetic force on the inner solenoid due to the outer one and \vec{F}_2 be the magnetic force on the outer solenoid due to the inner one. Then :
[2015]

Options:

- A. \vec{F}_1 is radially inwards and $\vec{F}_2 = 0$
- B. \vec{F}_1 is radially outwards and $\vec{F}_2 = 0$
- C. $\vec{F}_1 = \vec{F}_2 = 0$
- D. \vec{F}_1 is radially inwards and \vec{F}_2 is radially outwards

Answer: C

Solution:

Solution:

$$\vec{F}_1 = \vec{F}_2 = 0$$

because of action and reaction pair

Question153

A rectangular loop of sides 10 cm and 5 cm carrying a current I of 12 A is placed in different orientations as shown in the figures below :

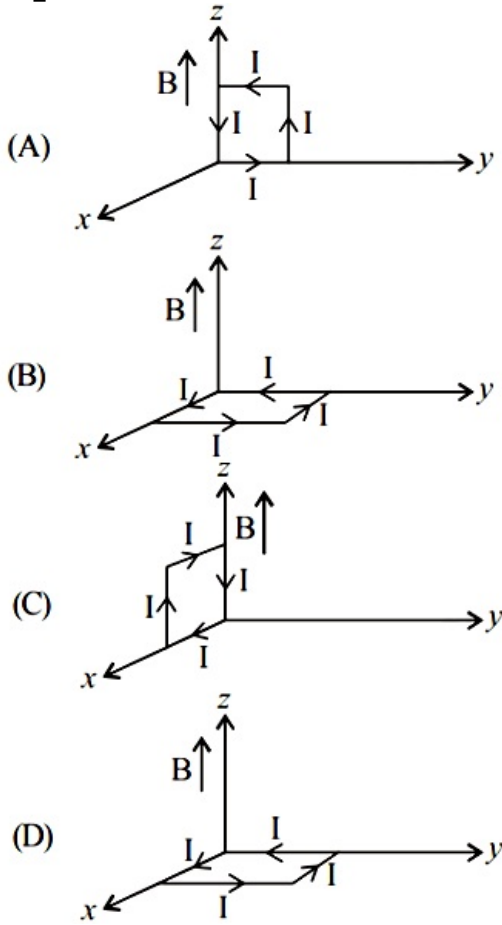

If there is a uniform magnetic field of 0.3T in the positive z direction, in which orientations the loop would be in (i) stable equilibrium and (ii) unstable equilibrium?

[2015]

Options:

- A. (B) and (D), respectively
- B. (B) and (C), respectively
- C. (A) and (B), respectively
- D. (A) and (C), respectively

Answer: A

Solution:

Solution:

For stable equilibrium $\vec{M} \parallel \vec{B}$

For unstable equilibrium $\vec{M} \parallel (-\vec{B})$

Question154

Two long straight parallel wires, carrying (adjustable) current I_1 and I_2 ,

are kept at a distance d apart. If the force ' F ' between the two wires is taken as 'positive' when the wires repel each other and 'negative' when the wires attract each other, the graph showing the dependence of ' F ', on the product $I_1 I_2$, would be :

[Online April 11, 2015]

Options:

A.

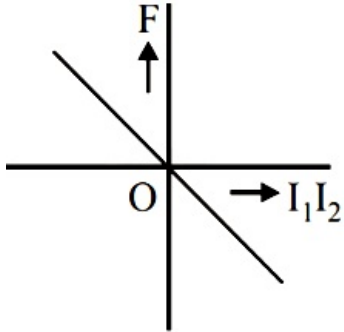

B.

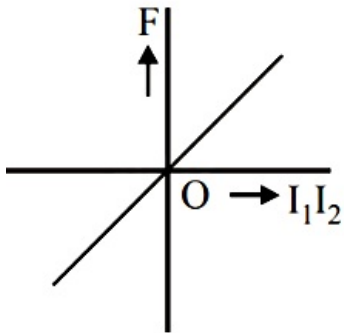

C.

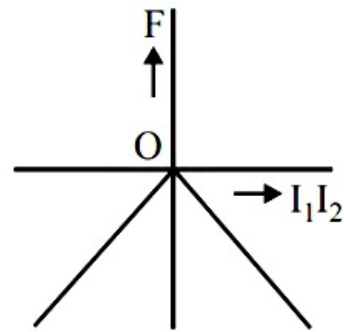

D.

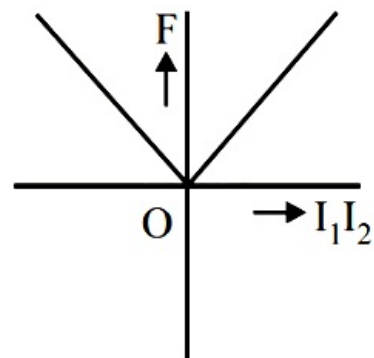

Answer: A

Solution:

Solution:

$I_1 I_2 = \text{Positive}$

(attract) $F = \text{Negative}$

$I_1 I_2 = \text{Negative}$

(repell) $F = \text{Positive}$

Hence, option (a) is the correct answer.

Question 155

A wire carrying current I is tied between points P and Q and is in the shape of a circular arc of radius R due to a uniform magnetic field B (perpendicular to the plane of the paper, shown by $\times \times \times$) in the vicinity of the wire. If the wire subtends an angle $2\theta_0$ at the centre of the circle (of which it forms an arc) then the tension in the wire is :

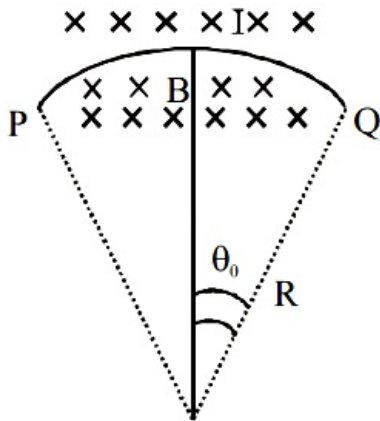

[Online April 11, 2015]

Options:

A. $\frac{I BR}{2 \sin \theta_0}$

B. $\frac{I BR \theta_0}{\sin \theta_0}$

C. IBR

D. $\frac{I BR}{\sin \theta_0}$

Answer: C

Solution:

Solution:

For small arc length

$$2T \sin \theta = BIR 2\theta \quad (\text{As } F = BIL \text{ and } L = RZ\theta)$$

$$T = BIR$$

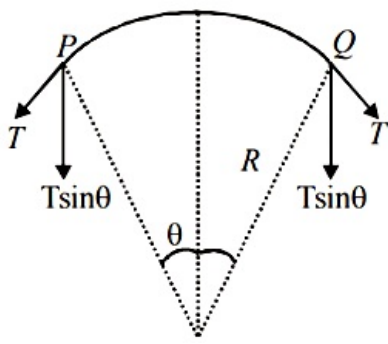

Question156

The AC voltage across a resistance can be measured using a :
[Online April 11, 2015]

Options:

- A. hot wire voltmeter
- B. moving coil galvanometer
- C. potential coil galvanometer
- D. moving magnet galvanometer

Answer: B

Solution:

Solution:

To measure AC voltage across a resistance a moving coil galvanometer is used.

Question157

A positive charge 'q' of mass 'm' is moving along the +x axis. We wish to apply a uniform magnetic field B for time Δt so that the charge reverses its direction crossing the y axis at a distance d. Then:
[Online April 12, 2014]

Options:

- A. $B = \frac{mv}{qd}$ and $\Delta t = \frac{\pi d}{v}$
- B. $B = \frac{mv}{2qd}$ and $\Delta t = \frac{\pi d}{2v}$
- C. $B = \frac{2mv}{qd}$ and $\Delta t = \frac{\pi d}{2v}$
- D. $B = \frac{2mv}{qd}$ and $\Delta t = \frac{\pi d}{v}$

Answer: C

Solution:

Solution:

The applied magnetic field provides the required centripetal force to the charge particle, so it can move in circular path of radius $\frac{d}{2}$

$$\therefore Bqv = \frac{mv^2}{d/2}$$

$$\text{or, } B = \frac{2mv}{qd}$$

Time interval for which a uniform magnetic field is applied $\Delta t = \frac{\pi \cdot \frac{d}{2}}{v}$

(particle reverses its direction after time Δt by covering semi circle).

$$\Delta t = \frac{\pi d}{2v}$$

Question158

Consider two thin identical conducting wires covered with very thin insulating material. One of the wires is bent into a loop and produces magnetic field B_1 , at its centre when a current I passes through it. The ratio $B_1 : B_2$ is:

[Online April 12, 2014]

Options:

A. 1: 1

B. 1: 3

C. 1: 9

D. 9: 1

Answer: B

Solution:

Solution:

$$\text{For loop } B = \frac{\mu_0 n I}{2a}$$

where, a is the radius of loop. Then, $B_1 = \frac{\mu_0 I}{2a}$

$$\text{Now, for coil } B = \frac{\mu_0 I}{4\pi} \cdot \frac{2nA}{x^3}$$

at the centre $x =$ radius of loop

$$B_2 = \frac{\mu_0}{4\pi} \cdot \frac{2 \times 3 \times (I/3) \times \pi(a/3)^2}{(a/3)^3} = \frac{\mu_0 \cdot 3I}{2a}$$

$$\therefore \frac{B_1}{B_2} = \frac{\mu_0 I / 2a}{\mu_0 \cdot 3I / 2a}$$

$$B_1 : B_2 = 1 : 3$$

Question159

A conductor lies along the z -axis at $-1.5 \leq z < 1.5\text{m}$ and carries a fixed current of 10.0 A in $-\hat{a}_z$ direction (see figure). For a field

$\vec{B} = 3.0 \times 10^{-4} e^{-0.2x} \hat{a}_y \text{ T}$, find the power required to move the conductor at constant speed to $x = 2.0\text{m}$ $y = 0\text{m}$ in $5 \times 10^{-3}\text{s}$. Assume parallel motion along the X -axis.

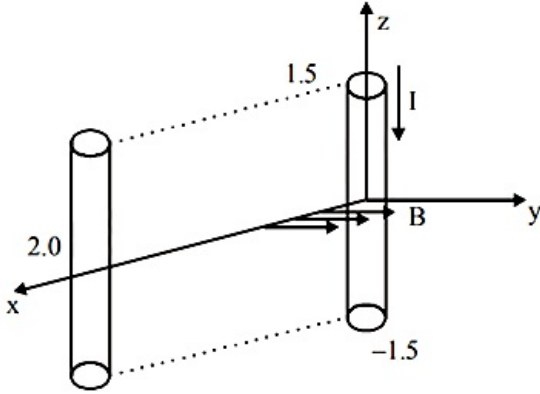

[2014]

Options:

- A. 1.57W
- B. 2.97W
- C. 14.85W
- D. 29.7W

Answer: B

Solution:

Solution:

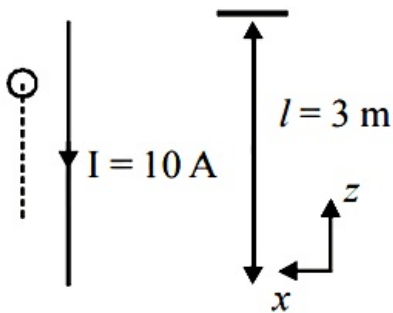

Work done in moving the conductor is,

$$\begin{aligned}
 W &= \int_0^2 F dx = \int_0^2 3.0 \times 10^{-4} e^{-0.2x} \times 10 \times 3 dx \\
 &= 9 \times 10^{-3} \int_0^2 e^{-0.2x} dx \\
 &= \frac{9 \times 10^{-3}}{0.2} [-e^{-0.2 \times 2} + 1] \\
 &= \frac{9 \times 10^{-3}}{0.2} \times [1 - e^{-0.4}] \\
 &= \frac{9 \times 10^{-3} \times (0.33)}{2} = \frac{2.97 \times 10^{-3}}{2}
 \end{aligned}$$

Power required to move the conductor is, $P = \frac{W}{t}$

$$P = \frac{2.97 \times 10^{-3}}{(0.2) \times 5 \times 10^{-3}} = 2.97\text{W}$$

Question 160

Three straight parallel current carrying conductors are shown in the figure. The force experienced by the middle conductor of length 25cm is:

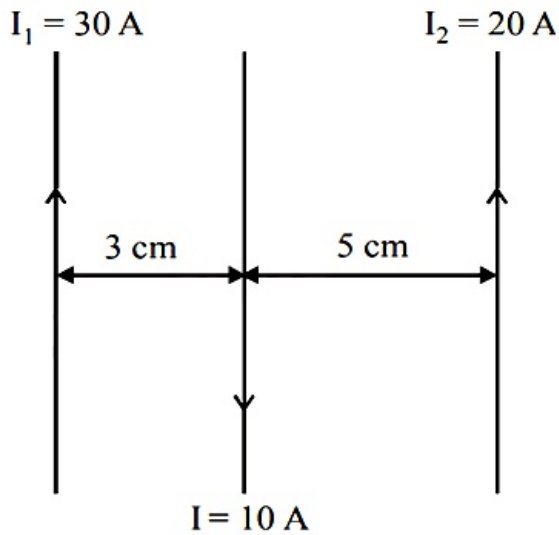

[Online April 11, 2014]

Options:

- A. $3 \times 10^{-4} \text{ N}$ toward right
- B. $6 \times 10^{-4} \text{ N}$ toward right
- C. $9 \times 10^{-4} \text{ N}$ toward right
- D. Zero

Answer: A

Solution:

Solution:

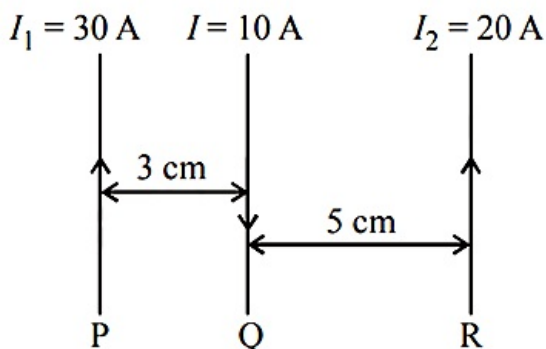

Also given; length of wire Q
= 25cm = 0.25m

Force on wire Q due to wire R

$$F_{QR} = 10^{-7} \times \frac{2 \times 20 \times 10}{0.05} \times 0.25$$

$$= 20 \times 10^{-5} \text{ N (Towards left)}$$

Force on wire Q due to wire P

$$F_{QP} = 10^{-7} \times \frac{2 \times 30 \times 10}{0.03} \times 0.25$$

$$= 50 \times 10^{-5} \text{ N (Towards right)}$$

Hence, $F_{\text{net}} = F_{QP} - F_{QR}$

$$= 50 \times 10^{-5} \text{N} - 20 \times 10^{-5} \text{N}$$

$$= 3 \times 10^{-4} \text{N} \text{ towards right}$$

Question 161

In the circuit diagrams (A, B, C and D) shown below, R is a high resistance and S is a resistance of the order of galvanometer resistance G. The correct circuit, corresponding to the half deflection method for finding the resistance and figure of merit of the galvanometer, is the circuit labelled as:

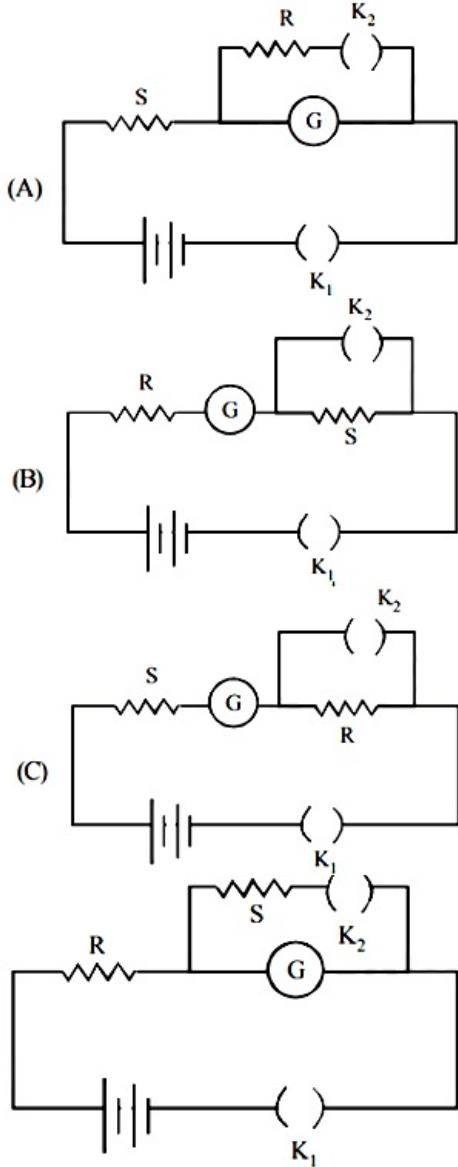

[Online April 11, 2014]

Options:

- A. Circuit A with $G = \frac{RS}{(R - S)}$
- B. Circuit B with $G = S$
- C. Circuit C with $G = S$
- D. Circuit D with $G = \frac{RS}{(R - S)}$

Answer: D

Solution:

Solution:

The correct circuit diagram is D with galvanometer resistance

$$G = \frac{RS}{R - S}$$

Question162

A particle of charge $16 \times 10^{-16} \text{C}$ moving with velocity 10ms^{-1} along x - axis enters a region where magnetic field of induction \vec{B} is along the y - axis and an electric field of magnitude 10^4V m^{-1} is along the negative z - axis. If the charged particle continues moving along x -axis, the magnitude of \vec{B} is:
[Online April 23, 2013]

Options:

- A. $16 \times 10^3 \text{W bm}^{-2}$
- B. $2 \times 10^3 \text{W bm}^{-2}$
- C. $1 \times 10^3 \text{W bm}^{-2}$
- D. $4 \times 10^3 \text{W bm}^{-2}$

Answer: C

Solution:

Solution:

Since particle is moving undeflected

So, $q_E = qvB$

$$\Rightarrow B = \frac{E}{V} = \frac{10^4}{10} = 10^3 \text{wb / m}^2$$

Question163

A parallel plate capacitor of area 60cm^2 and separation 3 mm is charged initially to $90 \mu\text{C}$. If the medium between the plate gets slightly conducting and the plate loses the charge initially at the rate of $2.5 \times 10^{-8} \text{C / s}$, then what is the magnetic field between the plates?
[Online April 23,2013]

Options:

- A. $2.5 \times 10^{-8} \text{T}$
- B. $2.0 \times 10^{-7} \text{T}$



C. $1.63 \times 10^{-11} \text{T}$

D. Zero

Answer: D

Solution:

Solution:

Magnetic field between the plates in this case is zero.

Question164

A current i is flowing in a straight conductor of length L . The magnetic induction at a point on its axis at a distance $\frac{L}{4}$ from its centre will be :

[Online April 22, 2013]

Options:

A. Zero

B. $\frac{\mu_0 i}{2\pi L}$

C. $\frac{\mu_0 i}{\sqrt{2}L}$

D. $\frac{4\mu_0 i}{\sqrt{5}\pi L}$

Answer: A

Solution:

Solution:

Magnetic field at any point lies on axial position of current carrying conductor $B = 0$

Question165

Choose the correct sketch of the magnetic field lines of a circular current loop shown by the dot \odot and the cross \otimes

[Online April 22, 2013]

Options:

A.

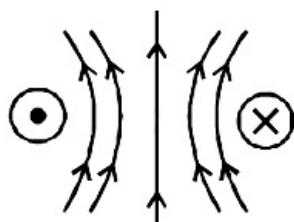

B.

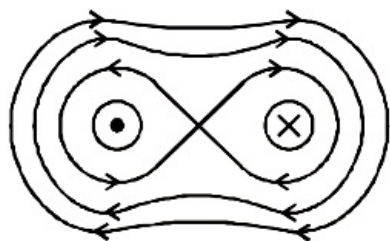

C.

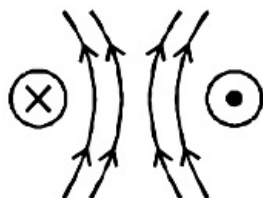

D.

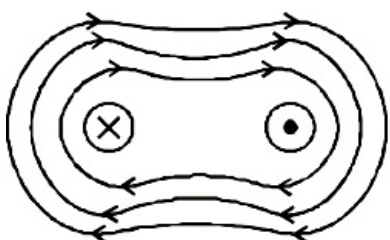

Answer: A

Solution:

Solution:

If magnetic field is perpendicular and into the plane of the paper, it is represented by cross \otimes and if the direction of the magnetic field is perpendicular out of the plane of the paper it is represented by dot \odot .

Question166

An electric current is flowing through a circular coil of radius R . The ratio of the magnetic field at the centre of the coil and that at a distance $2\sqrt{2}R$ from the centre of the coil and on its axis is :
[Online April 9, 2013]

Options:

A. $2\sqrt{2}$

B. 27

C. 36

D. 8

Answer: B

Solution:



Given : Radius = R

Distance $x = 2\sqrt{2}R$

$$\frac{B_{\text{centre}}}{B_{\text{axis}}} = \left(1 + \frac{x^2}{R^2}\right)^{3/2} = \left(1 + \frac{(2\sqrt{2}R)^2}{R^2}\right)^{3/2}$$
$$= (9)^{3/2} = 27$$

Question 167

A rectangular loop of wire, supporting a mass m , hangs with one end in a uniform magnetic field \vec{B} pointing out of the plane of the paper. A clockwise current is set up such that $i > mg / Ba$, where a is the width of the loop. Then :

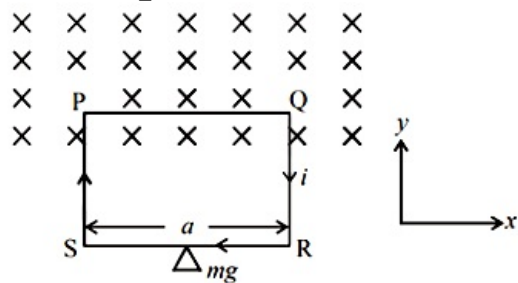

[Online April 23, 2013]

Options:

- A. The weight rises due to a vertical force caused by the magnetic field and work is done on the system.
- B. The weight do not rise due to vertical for caused by the magnetic field and work is done on the system.
- C. The weight rises due to a vertical force caused by the magnetic field but no work is done on the system
- D. The weight rises due to a vertical force caused by the magnetic field and work is extracted from the magnetic field.

Answer: C

Solution:

Solution:

Question 168

This questions has Statement I and Statement II. Of the four choices given after the Statements, choose the one that best describes into two Statements.

Statement-I : Higher the range, greater is the resistance of ammeter.

Statement-II : To increase the range of ammeter, additional shunt needs to be used across it.

[2013]



Options:

- A. Statement-I is true, Statement-II is true, Statement-II is the correct explanation of Statement-I.
- B. Statement-I is true, Statement-II is true, Statement-II is not the correct explanation of Statement-I.
- C. Statement-I is true, Statement-II is false.
- D. Statement-I is false, Statement-II is true.

Answer: D

Solution:

Statements I is false and Statement II is true

For ammeter, shunt resistance, $S = \frac{I_g G}{I - I_g}$

Therefore for I to increase, S should decrease, So additional S can be connected across it.

Question 169

To find the resistance of a galvanometer by the half deflection method the following circuit is used with resistances $R_1 = 9970\Omega$, $R_2 = 30\Omega$ and $R_3 = 0$. The deflection in the galvanometer is d . With $R_3 = 107\Omega$ the deflection changed to $\frac{d}{2}$. The galvanometer resistance is approximately:

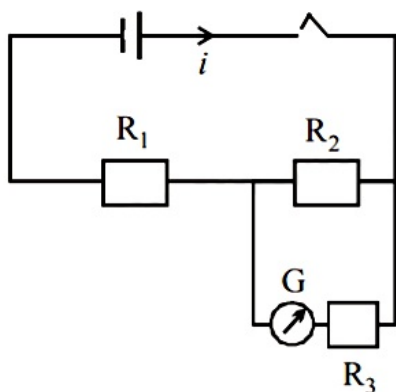

[Online April 22, 2013]

Options:

- A. 107Ω
- B. 137Ω
- C. $107 / 2\Omega$
- D. 77Ω

Answer: D

Question170

A shunt of resistance 1Ω is connected across a galvanometer of 120Ω resistance. A current of 5.5 ampere gives full scale deflection in the galvanometer. The current that will give full scale deflection in the absence of the shunt is nearly :
[Online April 9, 2013]

Options:

- A. 5.5 ampere
- B. 0.5 ampere
- C. 0.004 ampere
- D. 0.045 ampere

Answer: D

Solution:

Solution:

The current that will given full scale deflection in the absence of the shunt is nearly equal to the current through the galvanometer when shunt is connected i.e. I_g

$$\begin{aligned} \text{As } I_g &= \frac{IS}{G+S} \\ &= \frac{5.5 \times 1}{120+1} = 0.045 \text{ ampere} \end{aligned}$$

Question171

Proton, deuteron and alpha particle of same kinetic energy are moving in circular trajectories in a constant magnetic field. The radii of proton, deuteron and alpha particle are respectively r_p , r_d and r_α . Which one of the following relation is correct?
[2012]

Options:

- A. $r_\alpha = r_p = r_d$
- B. $r_\alpha = r_p < r_d$
- C. $r_\alpha > r_d > r_p$
- D. $r_\alpha = r_d > r_p$

Answer: B

Solution:

Solution:

The centripetal force is provided by the magnetic force

$$\therefore \frac{mv^2}{R} = qvB \Rightarrow r = \frac{mv}{Bq} \therefore r \propto \frac{\sqrt{m}}{q}$$

$$\therefore r_p : r_d : r_\alpha = \frac{\sqrt{m_p}}{q_p} : \frac{\sqrt{m_d}}{q_d} : \frac{\sqrt{m_\alpha}}{q_\alpha}$$

$$= 1 : \sqrt{2} : 1$$

Thus we have, $r_\alpha = r_p < r_d$

Question172

This question has Statement 1 and Statement 2 . Of the four choices given after the Statements, choose the one that best describes the two Statements.

Statement 1 : A charged particle is moving at right angle to a static magnetic field. During the motion the kinetic energy of the charge remains unchanged.

Statement 2: Static magnetic field exert force on a moving charge in the direction perpendicular to the magnetic field.

[Online May 26, 2012]

Options:

A. Statement 1 is false, Statement 2 is true.

B. Statement 1 is true, Statement 2 is true, Statement 2 is not the correct explanation of Statement 1.

C. Statement 1 is true, Statement 2 is false.

D. Statement 1 is true, Statement 2 is true, Statement 2 is the correct explanation of Statement 1.

Answer: D

Solution:

Solution:

When a charged particle enters the magnetic field in perpendicular direction then it experience a force in perpendicular direction.

$$\text{i.e. } F = Bqv \sin \theta$$

Due to which it moves in a circular path.

Question173

A proton and a deuteron are both accelerated through the same potential difference and enter in a magnetic field perpendicular to the direction of the field. If the deuteron follows a path of radius R,



assuming the neutron and proton masses are nearly equal, the radius of the proton's path will be [Online May 19, 2012]

Options:

A. $\sqrt{2}R$

B. $\frac{R}{\sqrt{2}}$

C. $\frac{R}{2}$

D. R

Answer: B

Solution:

Solution:

As charge on both proton and deuteron is same i.e. 'e'

Energy acquired by both,

$$E = eV$$

For Deuteron.

$$\text{Kinetic energy, } \frac{1}{2}mV^2 = eV \text{ [V is the potential difference]}$$

$$v = \sqrt{\frac{2eV}{m_d}}$$

$$\text{But } m_d = 2m$$

$$\text{Therefore, } v = \sqrt{\frac{2eV}{2m}} = \sqrt{\frac{eV}{m}}$$

$$\text{Radius of path, } R = \frac{mv}{eB}$$

Substituting value of 'v' we get

$$R = \frac{2m \sqrt{\frac{eV}{m}}}{eB}$$

$$\frac{R}{2} = \frac{m \sqrt{\frac{eV}{m}}}{eB} \dots\dots(i)$$

For proton :

$$\frac{1}{2}mV^2 = eV$$

$$V = \sqrt{\frac{2eV}{m}}$$

$$\text{Radius of path, } R' = \frac{mV}{eB} = \frac{m \sqrt{\frac{2eV}{m}}}{eB}$$

$$R' = \sqrt{2} \times \frac{R}{2} \text{ [From eq. (i)]}$$

$$R' = \frac{R}{\sqrt{2}}$$

Question174

The magnetic force acting on charged particle of charge 2 μC in magnetic field of 2T acting in y-direction, when the particle velocity is

$$(2\hat{i} + 3\hat{j}) \times 10^6 \text{ms}^{-1} \text{ is}$$



[Online May 12, 2012]

Options:

- A. 8N in z-direction
- B. 8N in y-direction
- C. 4N in y-direction
- D. 4N in z-direction

Answer: A

Solution:

Solution:

$$\begin{aligned}\vec{F} &= q(\vec{V} \times \vec{B}) \\ &= 2 \times 10^{-6} [(2\hat{i} + 3\hat{j}) \times 10^6 \times 2\hat{j}] \\ &= 2 \times 4\hat{k} = 8\text{N in Z -direction.}\end{aligned}$$

Question175

The velocity of certain ions that pass undeflected through crossed electric field $E = 7.7\text{kV / m}$ and magnetic field $B = 0.14\text{T}$ is [Online May 7, 2012]

Options:

- A. 18km / s
- B. 77km / s
- C. 55km / s
- D. 1078km / s

Answer: C

Solution:

Solution:

$$\text{As velocity } v = \frac{E}{B} = \frac{7.7 \times 10^3}{0.14} = 55\text{km / s}$$

Question176

A charge Q is uniformly distributed over the surface of non-conducting disc of radius R. The disc rotates about an axis perpendicular to its plane and passing through its centre with an angular velocity ω . As a result of this rotation a magnetic field of induction B is obtained at the centre of the disc. If we keep both the amount of charge placed on the



disc and its angular velocity to be constant and vary the radius of the disc then the variation of the magnetic induction at the centre of the disc will be represented by the figure :

[2012]

Options:

A.

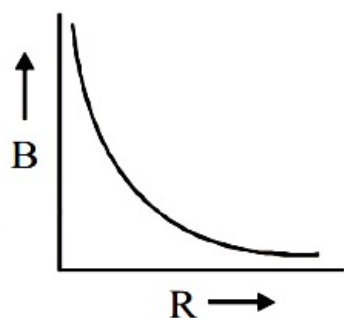

B.

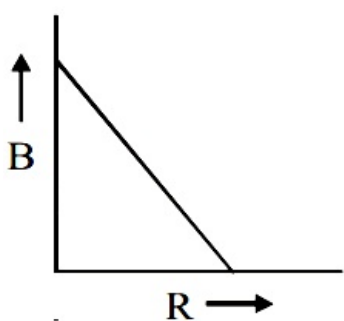

C.

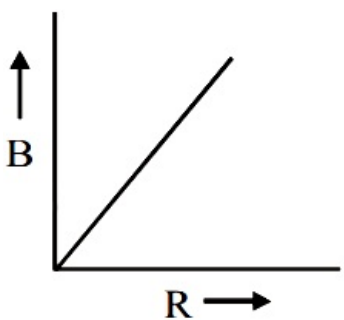

D.

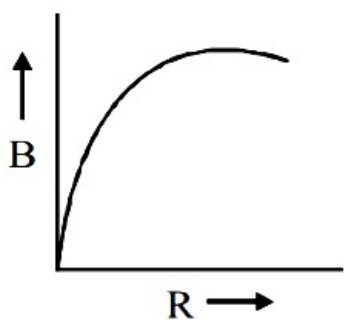

Answer: A

Solution:

The magnetic field due to a disc is given as

$$B = \frac{\mu_0 \omega Q}{2\pi R} \text{ i.e., } B \propto \frac{1}{R}$$

Question177

Currents of a 10 ampere and 2 ampere are passed through two parallel thin wires A and B respectively in opposite directions. Wire A is infinitely long and the length of the wire B is 2m. The force acting on the conductor B, which is situated at 10cm distance from A will be [Online May 26, 2012]

Options:

- A. $8 \times 10^{-5} \text{N}$
- B. $5 \times 10^{-5} \text{N}$
- C. $8\pi \times 10^{-7} \text{N}$
- D. $4\pi \times 10^{-7} \text{N}$

Answer: A

Solution:

Solution:

Force acting on conductor B due to conductor A is given by relation

$$F = \frac{\mu_0 I_1 I_2 l}{2\pi r}$$

l -length of conductor B

r -distance between two conductors

$$\therefore F = \frac{4\pi \times 10^{-7} \times 10 \times 2 \times 2}{2 \times \pi \times 0.1} = 8 \times 10^{-5} \text{N}$$

Question178

The circuit in figure consists of wires at the top and bottom and identical springs as the left and right sides. The wire at the bottom has a mass of 10g and is 5cm long. The wire is hanging as shown in the figure. The springs stretch 0.5 cm under the weight of the wire and the circuit has a total resistance of 12Ω . When the lower wire is subjected to a static magnetic field, the springs, stretch an additional 0.3cm. The magnetic field is



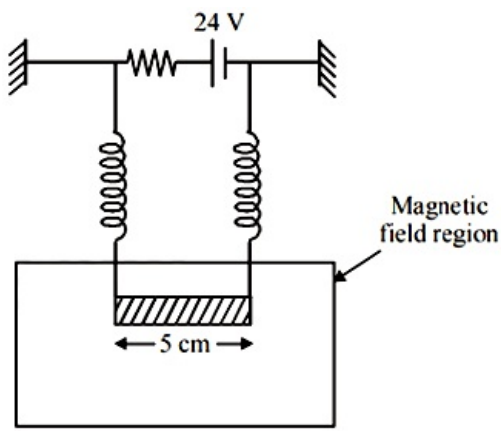

[Online May 12,2012]

Options:

- A. 0.6T and directed out of page
- B. 1.2T and directed into the plane of page
- C. 0.6T and directed into the plane of page
- D. 1.2T and directed out of page

Answer: A

Solution:

Solution:

Question179

An electric charge +q moves with velocity $\vec{v} = 3\hat{i} + 4\hat{j} + \hat{k}$ in an electromagnetic field given by $\vec{E} = 3\hat{i} + \hat{j} + 2\hat{k}$ and $\vec{B} = \hat{i} + \hat{j} - 3\hat{k}$ The y - component of the force experienced by + q is :

[2011 RS]

Options:

- A. 11q
- B. 5q
- C. 3q
- D. 2q

Answer: A

Solution:

Solution:

The charge experiences both electric and magnetic force .

Electric force, $F_e = qE$

Magnetic force, $F_m = q(\vec{v} \times \vec{B})$

$$\therefore \text{Net force, } \vec{F} = q[\vec{E} + \vec{v} \times \vec{B}]$$

$$= q \left[3\hat{i} + \hat{j} + 2\hat{k} + \begin{vmatrix} \hat{i} & \hat{j} & \hat{k} \\ 3 & 4 & 1 \\ 1 & 1 & -3 \end{vmatrix} \right]$$

$$= q[3\hat{i} + \hat{j} + 2\hat{k} + \hat{i}(-12 - 1) - \hat{j}(-9 - 1) + \hat{k}(3 - 4)]$$

$$= q[3\hat{i} + \hat{j} + 2\hat{k} - 13\hat{i} + 10\hat{j} - \hat{k}]$$

$$= q[-10\hat{i} + 11\hat{j} + \hat{k}]$$

$$F_y = 11qj$$

Thus, the y component of the force

Question 180

A current I flows in an infinitely long wire with cross section in the form of a semi-circular ring of radius R . The magnitude of the magnetic induction along its axis is:

[2011]

Options:

A. $\frac{\mu_0 I}{2\pi^2 R}$

B. $\frac{\mu_0 I}{2\pi R}$

C. $\frac{\mu_0 I}{4\pi R}$

D. $\frac{\mu_0 I}{\pi^2 R}$

Answer: D

Solution:

Solution:

Let R be the radius of semicircular ring. Let an elementary length $d l$ is cut for finding magnetic field. So, $d l = R d \theta$.

Current in a small element, $d I = \frac{d \theta}{\pi} I$

Magnetic field due to the element

$$d B = \frac{\mu_0 2 d I}{4\pi R} = \frac{\mu_0 I}{2\pi^2 R}$$

The component $d B \cos \theta$, of the field is cancelled by another opposite component.

Therefore,

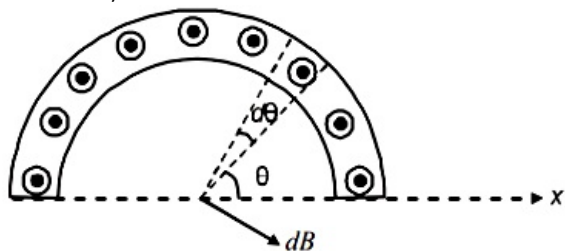

$$B_{\text{net}} = \int d B \sin \theta = \frac{\mu_0 I}{2\pi^2 R} \int_0^{\pi} \sin \theta d \theta = \frac{\mu_0 I}{\pi^2 R}$$

Question 181

Two long parallel wires are at a distance $2d$ apart. They carry steady equal currents flowing out of the plane of the paper as shown. The variation of the magnetic field B along the line XX' is given by [2010]

Options:

A.

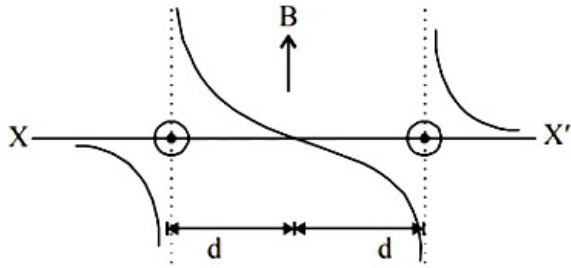

B.

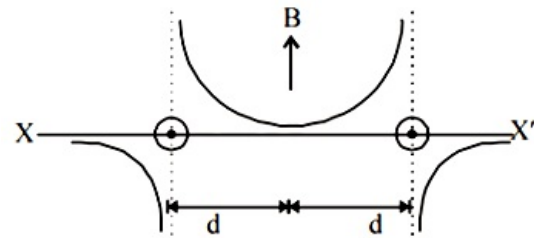

C.

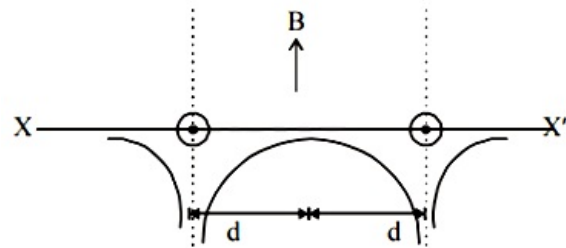

D.

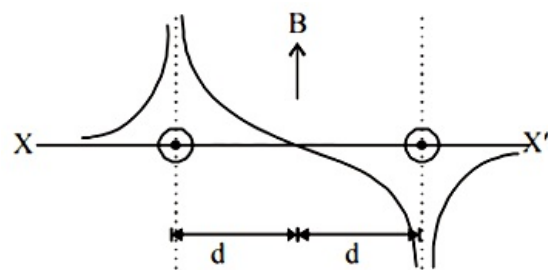

Answer: A

Solution:

Solution:

The magnetic field varies inversely with the distance for a long conductor. That is, $B \propto \frac{1}{d}$ so, graph in option (a) is the correct one.

Question182

The magnitude of the magnetic field (**B**) due to the loop ABCD at the origin (**O**) is :
[2009]

Options:

A. $\frac{\mu_0 I (b - a)}{24ab}$

B. $\frac{\mu_0 I}{4\pi} \left[\frac{b - a}{ab} \right]$

C. $\frac{\mu_0 I}{4p} [2(b - a) + p / 3(a + b)]$

D. zero

Answer: A

Solution:

Solution:

The magnetic field at O due to current in DA is

$$B_1 = \frac{\mu_0 I}{4\pi a} \times \frac{\pi}{6} \text{ (directed vertically upwards)}$$

The magnetic field at O due to current in BC is

$$B_2 = \frac{\mu_0 I}{4\pi b} \times \frac{\pi}{6} \text{ (directed vertically downwards)}$$

The magnetic field due to current AB and CD at O is zero.

Therefore the net magnetic field is $B = B_1 - B_2$ (directed vertically upwards)

$$\begin{aligned} &= \frac{\mu_0 I \pi}{4\pi a 6} - \frac{\mu_0 I \pi}{4\pi b 6} \times \frac{\pi}{6} \\ &= \frac{\mu_0 I}{24} \left(\frac{1}{a} - \frac{1}{b} \right) = \frac{\mu_0 I}{24ab} (b - a) \end{aligned}$$

Question183

Due to the presence of the current I_1 at the origin:
[2009]

Options:

A. The forces on AD and BC are zero.

B. The magnitude of the net force on the loop is given by $\frac{I_1 I}{4p} \mu_0 [2(b - a) + p / 3(a + b)]$

C. The magnitude of the net force on the loop is given by $\frac{\mu_0 I I_1}{24ab} (b - a)$

D. The forces on AB and DC are zero.

Answer: D



Solution:

Solution:

$$\vec{F} = I (\vec{l} \times \vec{B})$$

The force on AD and BC due to current I_1 is zero. This is because the directions of current element $I d\vec{l}$ and magnetic field \vec{B} are parallel.

Question184

A horizontal overhead powerline is at height of 4m from the ground and carries a current of 100A from east to west. The magnetic field directly below it on the ground is ($\mu_0 = 4\pi \times 10^{-7} \text{ Tm A}^{-1}$)

[2008]

Options:

- A. 2.5×10^{-7} T southward
- B. 5×10^{-6} T northward
- C. 5×10^{-6} T southward
- D. 2.5×10^{-7} T northward

Answer: C

Solution:

Solution:

The magnetic field is

$$B = \frac{\mu_0 2I}{4\pi r} = 10^{-7} \times \frac{2 \times 100}{4} = 5 \times 10^{-6} \text{ T}$$

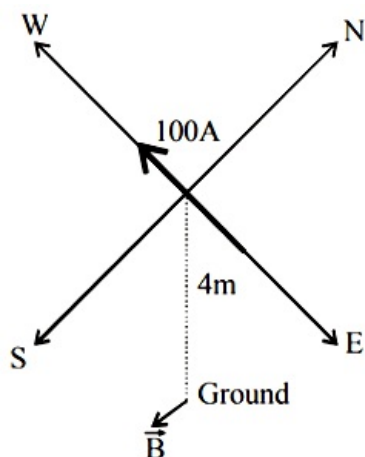

Current flows from east to west. Point is below the power line, using right hand thumb rule, the magnetic field is directed towards south.

Question185

A charged particle with charge q enters a region of constant, uniform



and mutually orthogonal fields \vec{E} and \vec{B} with a velocity \vec{v} perpendicular to both \vec{E} and \vec{B} and comes out without any change in magnitude or direction of \vec{v} . Then
[2007]

Options:

A. $\vec{v} = \vec{B} \times \vec{E} / E^2$

B. $\vec{v} = \vec{E} \times \vec{B} / B^2$

C. $\vec{v} = \vec{B} \times \vec{E} / B^2$

D. $\vec{v} = \vec{E} \times \vec{B} / E^2$

Answer: B

Solution:

Solution:

As velocity is not changing, charge particle must go undeflected, then

$$qE = qvB$$

$$\Rightarrow v = \frac{E}{B}$$

$$\text{Also, } \left| \frac{\vec{E} \times \vec{B}}{B^2} \right| = \frac{EB \sin \theta}{B^2}$$

$$= \frac{EB \sin 90^\circ}{B^2} = \frac{E}{B} = \left| \vec{v} \right| = v$$

Question 186

A charged particle moves through a magnetic field perpendicular to its direction. Then
[2007]

Options:

A. kinetic energy changes but the momentum is constant

B. the momentum changes but the kinetic energy is constant

C. both momentum and kinetic energy of the particle are not constant

D. both momentum and kinetic energy of the particle are constant

Answer: B

Solution:

Solution:

When a charged particle enters a magnetic field at a direction perpendicular to the direction of motion, the path of the motion is circular. In circular motion the direction of velocity changes at every point (the magnitude remains constant). Therefore, the tangential momentum will change at every point. But kinetic energy will remain constant as it is given by $\frac{1}{2}mv^2$ and v^2 is the square of the magnitude of velocity which does not change.

Question187

A long straight wire of radius a carries a steady current i . The current is uniformly distributed across its cross section. The ratio of the magnetic field at $a/2$ and $2a$ is [2007]

Options:

A. $1/2$

B. $1/4$

C. 4

D. 1

Answer: D

Solution:

Solution:

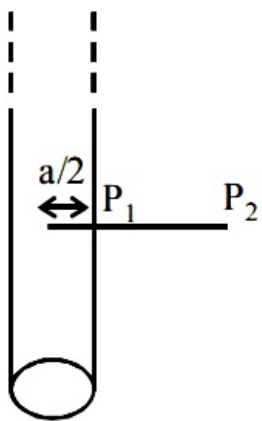

Since uniform current is flowing through a straight wire, current enclosed in the ampere an path formed at a distance

$r_1 \left(= \frac{a}{2} \right)$ is

$$i = \left(\frac{\pi r_1^2}{\pi a^2} \right) \times I,$$

where I is total current

Using Ampere circuital law,

$$\oint \vec{B} \cdot d\vec{l} = \mu_0 i$$

$$\Rightarrow B_1 = \frac{\mu_0 \times \text{current enclosed}}{\text{Path}}$$

$$\Rightarrow B_1 = \frac{\mu_0 \times \left(\frac{\pi r_1^2}{\pi a^2} \right) \times I}{2\pi r_1} = \frac{\mu_0 \times I r_1}{2\pi a^2}$$

Now, magnetic field induction at point

$$P_2, B_2 = \frac{\mu_0}{2\pi} \cdot \frac{I}{(2a)} = \frac{\mu_0 I}{4\pi a}$$

$$\therefore \frac{B_1}{B_2} = \frac{\mu_0 I r_1}{2\pi a^2} \times \frac{4\pi a}{\mu_0 I}$$

$$\Rightarrow \frac{B_1}{B_2} = \frac{2r_1}{a} = \frac{2 \times \frac{a}{2}}{a} = 1$$

Question 188

A current I flows along the length of an infinitely long, straight, thin walled pipe. Then
[2007]

Options:

- A. the magnetic field at all points inside the pipe is the same, but not zero
- B. the magnetic field is zero only on the axis of the pipe
- C. the magnetic field is different at different points inside the pipe
- D. the magnetic field at any point inside the pipe is zero

Answer: D

Solution:

Solution:

There is no current inside the pipe. From Ampere's circuital law $\oint \vec{B} \cdot d\vec{l} = \mu_0 I$
 $\therefore I = 0$
 $\therefore B = 0$

Question 189

Two identical conducting wires AOB and COD are placed at right angles to each other. The wire AOB carries an electric current I_1 and COD carries a current I_2 . The magnetic field on a point lying at a distance d from O, in a direction perpendicular to the plane of the wires AOB and COD, will be given by
[2007]

Options:

- A. $\frac{\mu_0}{2\pi d}(I_1^2 + I_2^2)$
- B. $\frac{\mu_0}{2\pi} \left(\frac{I_1 + I_2}{d} \right)^{\frac{1}{2}}$
- C. $\frac{\mu_0}{2\pi d}(I_1 + I_2)^{\frac{1}{2}}$
- D. $\frac{\mu_0}{2\pi d}(I_1 + I_2)$

Answer: C

Solution:

The direction of magnetic field induction due to current through AB and CD at P are indicated as B_1 and B_2 . The magnetic fields at a point P, equidistant from AOB and COD will have directions perpendicular to each other, as they are placed normal to each other.

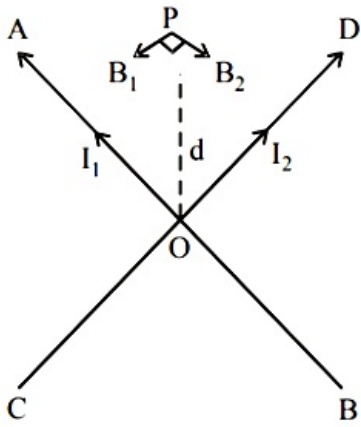

Magnetic field at P due to current through AB,

$$B_1 = \frac{\mu_0 I_1}{2\pi d}$$

Magnetic field at P due to current through CD

$$B_2 = \frac{\mu_0 I_2}{2\pi d}$$

$$\therefore \text{Resultant field, } B = \sqrt{B_1^2 + B_2^2}$$

$$\therefore B = \sqrt{\left(\frac{\mu_0}{2\pi d}\right)^2 (I_1^2 + I_2^2)}$$

$$\text{or, } B = \frac{\mu_0}{2\pi d} (I_1^2 + I_2^2)^{1/2}$$

Question190

In a region, steady and uniform electric and magnetic fields are present. These two fields are parallel to each other. A charged particle is released from rest in this region. The path of the particle will be a [2006]

Options:

- A. helix
- B. straight line
- C. ellipse
- D. circle

Answer: B

Solution:

The charged particle will move along the lines of electric field (and magnetic field). Magnetic field will exert no force. The force by electric field will be along the lines of uniform electric field. Hence the particle will move in a straight line.

Question191

A long solenoid has 200 turns per cm and carries a current i . The magnetic field at its centre is 6.28×10^{-2} Weber /m². Another long solenoid has 100 turns per cm and it carries a current $\frac{i}{3}$. The value of the magnetic field at its centre is [2006]

Options:

- A. 1.05×10^{-2} Weber/m²
- B. 1.05×10^{-5} Weber /m²
- C. 1.05×10^{-3} Weber /m²
- D. 1.05×10^{-4} Weber /m²

Answer: A

Solution:

Solution:

Magnetic field due to long solenoid is given by $B = \mu_0 nI$

In first case $B_1 = \mu_0 n_1 I_1$

In second case, $B_2 = \mu_0 n_2 I_2$

$$\therefore \frac{B_2}{B_1} = \frac{\mu_0 n_2 i_2}{\mu_0 n_1 i_1}$$

$$\Rightarrow \frac{B_2}{6.28 \times 10^{-2}} = \frac{100 \times \frac{i}{3}}{200 \times i}$$

$$\Rightarrow B_2 = \frac{6.28 \times 10^{-2}}{6} = 1.05 \times 10^{-2} \text{ W b / m}^2$$

Question192

A charged particle of mass m and charge q travels on a circular path of radius r that is perpendicular to a magnetic field B . The time taken by the particle to complete one revolution is [2005]

Options:

- A. $\frac{2\pi q^2 B}{m}$
- B. $\frac{2\pi m q}{B}$
- C. $\frac{2\pi m}{qB}$
- D. $\frac{2\pi q B}{m}$

Answer: C

Solution:

Equating magnetic force to centripetal force,

$$\frac{mv^2}{r} = qvB \sin 90^\circ$$

$$\Rightarrow \frac{mv}{r} = Bq \Rightarrow v = \frac{Bqr}{m}$$

Time to complete one revolution,

$$T = \frac{2\pi r}{v} = \frac{2\pi m}{qB}$$

Question 193

A uniform electric field and a uniform magnetic field are acting along the same direction in a certain region. If an electron is projected along the direction of the fields with a certain velocity then [2005]

Options:

- A. its velocity will increase
- B. Its velocity will decrease
- C. it will turn towards left of direction of motion
- D. it will turn towards right of direction of motion

Answer: B

Solution:

Solution:

Due to electric field, it experiences force and accelerates i.e. its velocity decreases.

Question 194

Two concentric coils each of radius equal to 2π cm are placed at right angles to each other. 3 ampere and 4 ampere are the currents flowing in each coil respectively. The magnetic induction in Weber /m² at the centre of the coils will be ($\mu_0 = 4\pi \times 10^{-7}$ W b / A . m)

[2005]

Options:

- A. 10^{-5}
- B. 12×10^{-5}
- C. 7×10^{-5}
- D. 5×10^{-5}

Answer: D



Solution:

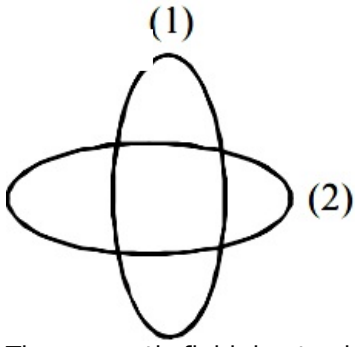

The magnetic field due to circular coil (1) is

$$B_1 = \frac{\mu_0 i_1}{2r} = \frac{\mu_0 i_1}{2(2\pi \times 10^{-2})} = \frac{\mu_0 \times 3 \times 10^2}{4\pi}$$

Magnetic field due to coil (2)

Total magnetic field

$$B_2 = \frac{\mu_0 i_2}{2(2\pi \times 10^{-2})} = \frac{\mu_0 \times 4 \times 10^2}{4\pi}$$

$$\text{Total magnetic field, } B = \sqrt{B_1^2 + B_2^2}$$

$$= \frac{\mu_0}{4\pi} \cdot 5 \times 10^2$$

$$\Rightarrow B = 10^{-7} \times 5 \times 10^2$$

$$\Rightarrow B = 5 \times 10^{-5} \text{ W b / m}^2$$

Question 195

In the circuit, the galvanometer G shows zero deflection. If the batteries A and B have negligible internal resistance, the value of the resistor R will be -

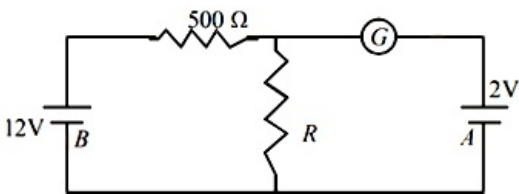

[2005]

Options:

A. 100Ω

B. 200Ω

C. 1000Ω

D. 500Ω

Answer: A

Solution:



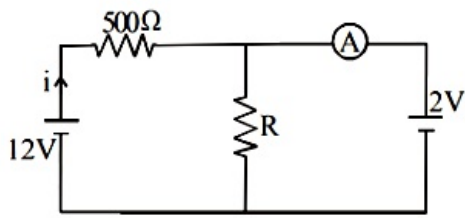

$$12 - 2 = (500\Omega)i \Rightarrow i = \frac{10}{500} = \frac{1}{50}$$

$$\text{Again, } i = \frac{12}{500 + R} = \frac{1}{50}$$

$$\Rightarrow 500 + R = 600$$

$$\Rightarrow R = 100\Omega$$

Question196

A moving coil galvanometer has 150 equal divisions. Its current sensitivity is 10 -divisions per milliampere and voltage sensitivity is 2 divisions per millivolt. In order that each division reads 1 volt, the resistance in ohms needed to be connected in series with the coil will be -

[2005]

Options:

- A. 10^5
- B. 10^3
- C. 9995
- D. 99995

Answer: D

Solution:

Solution:

Resistance of Galvanometer,

$$G = \frac{\text{Current sensitivity}}{\text{Voltage sensitivity}} \Rightarrow G = \frac{10}{2} = 5\Omega$$

$$\text{Here } i_g = \text{Full scale deflection current} = \frac{150}{10} = 15\text{mA}$$

V = voltage to be measured = 150 volts
(such that each division reads 1 volt)

$$\Rightarrow R = \frac{150}{15 \times 10^{-3}} - 5 = 9995\Omega$$

Question197

A current i ampere flows along an infinitely long straight thin walled tube, then the magnetic induction at any point inside the tube is
[2004]

Options:

A. $\frac{\mu_0}{4\pi} \cdot \frac{2i}{r}$ tesla

B. zero

C. infinite

D. $\frac{2i}{r}$ tesla

Answer: B

Solution:

Solution:

From Ampere's circuital law

$$\int \vec{B} \cdot d\vec{l} = \mu_0 i$$

$$\Rightarrow B \times 2\pi r = \mu_0 i$$

Here i is zero, for $r < R$, whereas R is the radius

$$\therefore B = 0$$

Question 198

A long wire carries a steady current. It is bent into a circle of one turn and the magnetic field at the centre of the coil is B . It is then bent into a circular loop of n turns. The magnetic field at the centre of the coil will be
[2004]

Options:

A. $2nB$

B. n^2B

C. nB

D. $2n^2B$

Answer: B

Solution:

Solution:

Magnetic field at the centre of a circular coil of radius R carrying current i is $B = \frac{\mu_0 i}{2R}$

The circumference of the first loop = $2\pi R$. If it is bent into n circular coil of radius r' .

$$n \times (2\pi r') = 2\pi R$$

$$\Rightarrow nr' = R \dots\dots(1)$$

$$\text{New magnetic field, } B' = \frac{n \cdot \mu_0 i}{2r'} \dots\dots(2)$$

From (1) and (2)

$$B' = \frac{n\mu_0 i \cdot n}{2\pi R} = n^2 B$$



Question199

The magnetic field due to a current carrying circular loop of radius 3 cm at a point on the axis at a distance of 4 cm from the centre is $54 \mu\text{T}$. What will be its value at the centre of loop?

[2004]

Options:

- A. $125 \mu\text{T}$
- B. $150 \mu\text{T}$
- C. $250 \mu\text{T}$
- D. $75 \mu\text{T}$

Answer: C

Solution:

Solution:

The magnetic field at a point on the axis of a circular loop at a distance x from centre is,

$$B = \frac{\mu_0 i a^2}{2(x^2 + a^2)^{3/2}}$$

Magnetic field at the centre of loop is

$$B' = \frac{\mu_0 i}{2a}$$

$$\therefore B' = \frac{B \cdot (x^2 + a^2)^{3/2}}{a^3}$$

Put $x = 4$ & $a = 3$

$$\Rightarrow B' = \frac{54(5^3)}{3 \times 3 \times 3} = 250 \mu\text{T}$$

Question200

Two long conductors, separated by a distance d carry current I_1 and I_2 in the same direction. They exert a force F on each other. Now the current in one of them is increased to two times and its direction is reversed. The distance is also increased to $3d$. The new value of the force between them is

[2004]

Options:

- A. $-\frac{2F}{3}$
- B. $\frac{F}{3}$
- C. $-2F$
- D. $-\frac{F}{3}$

Answer: A

Solution:

Force acting between two long conductor carrying current,

$$F = \frac{\mu_0 I_1 I_2 l}{4\pi d} \dots (i)$$

Where d = distance between the conductors

l = length of conductor

$$\text{In second case, } F' = -\frac{\mu_0 2(2I_1)I_2 l}{4\pi 3d} \dots (ii)$$

From equation (i) and (ii), we have

$$\therefore \frac{F'}{F} = \frac{-2}{3}$$

Question201

A particle of mass M and charge Q moving with velocity \vec{v} describe a circular path of radius R when subjected to a uniform transverse magnetic field of induction B . The work done by the field when the particle completes one full circle is [2003]

Options:

A. $\left(\frac{Mv^2}{R}\right) 2\pi R$

B. zero

C. $BQ2\pi R$

D. $BQv2\pi R$

Answer: B

Solution:

Solution:

The work done, $dW = F ds \cos \theta$

The angle between force and displacement is 90° Therefore work done is zero.

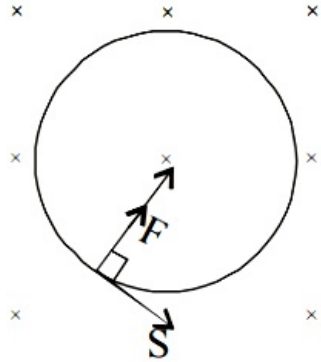

Question202

If an electron and a proton having same momenta enter perpendicular to a magnetic field, then [2002]

Options:

- A. curved path of electron and proton will be same (ignoring the sense of revolution)
- B. they will move undeflected
- C. curved path of electron is more curved than that of the proton
- D. path of proton is more curved.

Answer: A

Solution:

Solution:

When a moving charged particle is subjected to a perpendicular magnetic field, then it describes a circular path of radius.

$$r = \frac{p}{qB}$$

where q = Charge of the particle

p = Momentum of the particle

B = Magnetic field

Here p , q and B are constant for electron and proton, therefore the radius will be same

Question203

The time period of a charged particle undergoing a circular motion in a uniform magnetic field is independent of its [2002]

Options:

- A. speed
- B. mass
- C. charge
- D. magnetic induction

Answer: A

Solution:

Solution:

The time period of a charged particle of charge q and mass m moving in a magnetic field (B) is $T = \frac{2\pi m}{qB}$

Clearly time period is independent of speed of the particle.

Question204

If in a circular coil A of radius R, current I is flowing and in another coil B of radius 2R a current 2I is flowing, then the ratio of the magnetic fields B_A and B_B , produced by them will be

[2002]

Options:

- A. 1
- B. 2
- C. $\frac{1}{2}$
- D. 4

Answer: A

Solution:

Solution:

Magnetic field induction at the centre of current carrying circular coil of radius r is

$$B = \frac{\mu_0 I}{4\pi R} \times 2\pi$$

$$\text{Here } B_A = \frac{\mu_0 I}{4\pi R} \times 2\pi$$

$$\text{and } B_B = \frac{\mu_0 2I}{4\pi 2R} \times 2\pi$$

$$\Rightarrow \frac{B_A}{B_B} = \frac{I / R}{2I / 2R} = 1$$

Question205

If a current is passed through a spring then the spring will
[2002]

Options:

- A. expand
- B. compress
- C. remains same
- D. none of these

Answer: B

Solution:

Solution:

When current is passed through a spring then current flows parallel in the adjacent turns in the same direction. As a result the various turn attract each other and spring get compress.

Question 206

Wires 1 and 2 carrying currents i_1 and i_2 respectively are inclined at an angle θ to each other. What is the force on a small element dl of wire 2 at a distance of r from wire 1 (as shown in figure) due to the magnetic field of wire 1?

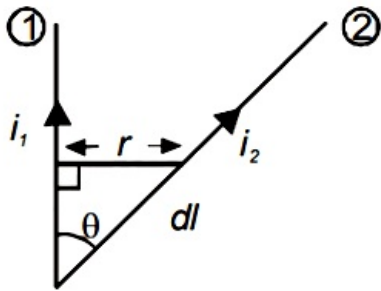

[2002]

Options:

- A. $\frac{\mu_0}{2\pi r} i_1 i_2 dl \tan \theta$
- B. $\frac{\mu_0}{2\pi r} i_1 i_2 dl \sin \theta$
- C. $\frac{\mu_0}{2\pi r} i_1 i_2 dl \cos \theta$
- D. $\frac{\mu_0}{4\pi r} i_1 i_2 dl \sin \theta$

Answer: C

Solution:

Magnetic field due to current in wire 1 at point P distant r from the wire is $B = \frac{\mu_0 i_1}{4\pi r} [\cos \theta + \cos \theta]$

$$B = \frac{\mu_0 i_1 \cos \theta}{2\pi r}$$

This magnetic field is directed perpendicular to the plane of paper, inwards.

The force exerted due to this magnetic field on current element $i_2 dl$ is

$$dF = i_2 dl B \sin 90^\circ$$

$$\therefore dF = i_2 dl B$$

$$\Rightarrow dF = i_2 dl \left(\frac{\mu_0 i_1 \cos \theta}{4\pi r} \right)$$

$$= \frac{\mu_0}{2\pi r} i_1 i_2 dl \cos \theta$$